

Bedienungsanleitung  
Operation manual  
Notice d'utilisation  
Instrucciones de servicio  
Istruzioni per l'uso

## TTT-300

Deutsche Version  
English Version  
Version française  
Versión española  
Versione italiana

# Operation Manual

## ToolTorqueTester TTT-300



# TTT-300

## Content

Bedienungsanleitung  
 Operation manual  
 Notice d'utilisation  
 Instrucciones de servicio  
 Istruzioni per l'uso

<b>1.0</b>	<b>General remarks</b>	<b>4</b>
1.1.	Used Symbols	4
<b>2.0</b>	<b>Safety instructions</b>	<b>5</b>
2.1.	Proper use	5
2.2.	Environmental conditions for safe operation	5
2.3.	Hazard Warnings	6
2.4.	Disclaimer	6
<b>3.0</b>	<b>Before starting operation</b>	<b>7</b>
3.1.	Scope of delivery	7
3.2.	Energy Harvesting	8
3.3.	Overview	8
3.4.	Set-up functions	9
3.5.	Control panel	10
<b>4.0</b>	<b>Starting Operation</b>	<b>11</b>
4.1.	Installation and connection	11
4.2.	Inserting the test object	12
4.3.	Turning the instrument ON/OFF	13
4.3.1.	Changing measuring units	13
4.4.	Selecting the measuring mode	14
4.4.1.	Standard (Default)	14
4.4.2.	Measuring mode: Peak CCW	15
4.4.3.	Measuring mode: Peak Actual-Value	15
4.4.4.	Measuring mode: Peak CW	16
4.5.	Start/Stop measurements	17
4.6.	Quick-Check	18
4.7.	Taring	19
4.8.	Reset the drag indicator	19
4.9.	View readings	20
4.9.1.	View readings in standard mode	20
4.9.2.	View results in peak modes	21
4.10.	Clear data	22
<b>5.0</b>	<b>Setting Measurement Parameters</b>	<b>23</b>
5.1.	Parameter Menu	23
5.2.	General settings (P1)	24
5.2.1.	Change measuring unit (P11)	25

# TTT-300

Bedienungsanleitung  
Operation manual  
Notice d'utilisation  
Instrucciones de servicio  
Istruzioni per l'uso

5.2.2.	Change prefix for CCW mode and CW mode (P12)	25
5.2.3.	Display-refresh rate (P13)	25
5.2.4.	Auto-Stop - automatic measuring stop (P14)	25
5.2.5.	Auto-Off function (instrument off) (P15)	26
5.2.6.	Auto-Tara - automatic taring (P16)	26
5.2.7.	Buzzer - activating the signal tone (P17)	26
<b>5.3.</b>	<b>Reset to factory defaults (PO)</b>	<b>27</b>
<b>5.4.</b>	<b>Memory and Statistics function (P2)</b>	<b>28</b>
5.4.1.	General explanation of the memory function	28
5.4.2.	Activating the memory and statistics function	28
5.4.3.	Storage of single values (P21)	29
5.4.4.	Activating Quick-Check (P22)	29
5.4.5.	View statistics	30
5.4.6.	Clear memory	30
<b>5.5.</b>	<b>Monitoring limit values (P3 bis P6)</b>	<b>31</b>
5.5.1.	Working with the limit value (threshold) function	31
5.5.2.	Setting limit values	32
5.5.3.	Delete limit values	32
<b>5.6.</b>	<b>Threshold for start of 2nd peak measurement</b>	<b>33</b>
<b>6.0</b>	<b>Data transfer</b>	<b>34</b>
<b>6.1.</b>	<b>Data transfer via USB</b>	<b>34</b>
6.1.1.	Software TTT_Certify	34
6.1.2.	TTT_Quick-Check	34
6.1.3.	TTT_Parameter-Check	35
6.1.4.	Software COM-Bridge (from quarter 04/2016)	35
<b>6.2.</b>	<b>Hirose socket</b>	<b>35</b>
6.2.1.	Foot switch for data transfer	35
6.2.2.	Data cable for digital I/Os	36
<b>7.0</b>	<b>Testing with test stand</b>	<b>37</b>
<b>8.0</b>	<b>Dimensions and CAD files</b>	<b>38</b>
<b>9.0</b>	<b>Specifications</b>	<b>39</b>
<b>10.0</b>	<b>Service</b>	<b>40</b>
10.1.	Extended 5-year warranty	40
10.2.	Product registration	40
10.3.	Calibration certificates	40
<b>11.0</b>	<b>Frequently asked questions (FAQ)</b>	<b>41</b>
<b>A.</b>	<b>Appendix</b>	<b>42</b>
A.1	Calibration confirmation acc. DIN EN 10204 2.1	42
A.2	Declaration of conformity	43

# TTT-300

Bedienungsanleitung  
Operation manual  
Notice d'utilisation  
Instrucciones de servicio  
Istruzioni per l'uso

Thank you for choosing one of our high quality instruments. Please read the entire operation manual thoroughly before using this instrument for the first time. The information contained herein will help you to achieve accurate and reproducible results and to avoid misuse or damages.

## 1.0 General remarks

### 1.1 Used Symbols

#### Note

Helpful information that facilitates the operation of the instrument.



#### Attention

Non-observance of the associated information may result in damage of the instrument.



#### Attention

Non-observance of the associated information may result in injury.



#### CE

The unit conforms to the applicable European directives.



#### WEEE Directive

The device is subject to the WEEE Directive.



#### Calibration certificate

The instrument was tested in certified calibration laboratory.



# TTT-300

Bedienungsanleitung  
Operation manual  
Notice d'utilisation  
Instrucciones de servicio  
Istruzioni per l'uso

## 2.0 Safety instructions

Instruct the operators according to the instructions in this manual. Deliver all information about the field of application and the possible hazards during operation. Keep this manual for future use at hand for the operation personnel.



### 2.1. Proper use

The ToolTorqueTester TTT-300 is designed to measure the triggering torque (click point) and the second maximum value of torque tools. It is used for torque testing and calibration of manual, indicating or clicking torque screwdrivers and torque wrenches. Combined with run down joint simulators it is designed to monitor the correct function of motorized torque drivers (but not for impulse wrenches).



The torque sensor may be damaged due to overload! Observe the maximum measuring range of your device! The maximum measuring range is indicated on the typeplate on the underside.

If you want to use the instrument for calibration, it should be operated mounted to a test stand. The portable ToolTorqueTester TTT-300 is designed for bench top use. At higher torques (from about 10 Nm), the device should be screwed to the tabletop. Use exclusively the provided bolts on the underside of the instrument.

### 2.2. Environmental conditions for safe operation

Observe the permissible environmental conditions for the instrument. It is designed for indoor use up to an altitude of 2,000 m above sea level. The instrument is equipped with an automatic temperature compensation from 0 ° ... 40 ° C (max. 85% RH). Use the device only under this conditions.



## 2.3. Hazard Warnings

- If the instrument is not operated according to this manual, the protection provided is no longer guaranteed.
- The instrument is intended for use by trained personnel. Operation and maintenance may only be performed by trained personnel. Repairs may be carried out only by Alluris or authorized servicing dealers.



## 2.4. Disclaimer

Alluris disclaims any damages or warranty claims when

- the instrument is used for other purposes than those specified in this operation manual;
- the product is changed in any way - other than those alterations described in this manual;
- the product is not repaired by Alluris or authorized servicing dealers;
- the product will be used despite obvious safety faults;
- the product is subjected to mechanical impacts or is dropped;
- accessories are used that have not been released by Alluris.



# TTT-300

Bedienungsanleitung  
Operation manual  
Notice d'utilisation  
Instrucciones de servicio  
Istruzioni per l'uso

## 3.0 Before starting operation

Please check the content before using the equipment. Make sure that the packaging and the device have no transport damage. If you suspect any damage from transport, please notify immediately our service.

If despite our careful final inspection any items are missing, please inform your dealer or our customer service via [service@alluris.de](mailto:service@alluris.de).

You find all items listed in table 3.1, if you want to order a replacement at a later date. Additional accessories on [www.alluris.de](http://www.alluris.de).

### 3.1. Scope of delivery

<ul style="list-style-type: none"><li>● Standard scope of delivery (part no.)</li><li>○ Optional accessories (not included)</li></ul>	TTT-300
Base unit (Typeplate with serial number and measuring range on the underside)	●
Quickstart manual	●
Standard 3/8" female socket (TTT-946)	●
Software Bundle TTT (TTT-930)	●
USB interface cable (FMI-931USB)	●
Universal VAC power supply (FMI-946)	●
Adapter male square 3/8" to female square 3/8" (TTT-941)	●
Adapter male square 3/8" to female square 1/4" (TTT-942)	●
Adapter male square 3/8" to male hex 5/16" (TTT-943)	●
Adapter male square 1/4" to male hex 5/32" (TTT-9414)	●
Adapter male square 1/4" to male square 1/4" (TTT-945)	●
Run down joint simulator (TTT-910xx)	○
Horizontal test stand for calibration (TTT-920)	○
Additional element for screwdrivers (TTT-921)	○
COM-Bridge (FMI-977) software license	○
Calibration certificate according to DAkkS-DKD-R 3-8 (TMI-820N2/TMI-820R2)	○
Protection case (CTT-908)	○

# TTT-300

Bedienungsanleitung  
 Operation manual  
 Notice d'utilisation  
 Instrucciones de servicio  
 Istruzioni per l'uso

## 3.2. Energy Harvesting

Tool Torque Tester TTT utilize, also when turned off, the ambient light at the work place as energy source. The energy is stored in the instrument, to ensure that tests can be made even if the solar cell is covered for a short while.

After keeping the instrument for more than 2 month in the dark, you should expose it to light for at least 8 hours in the regular working environment (> 250 Lux) before use. Or you may use the USB-cable to charge the instrument quickly. A buffer battery maintains in any case the basic functions of the instrument.

Control panel of ToolTorqueTester TTT with solar cell

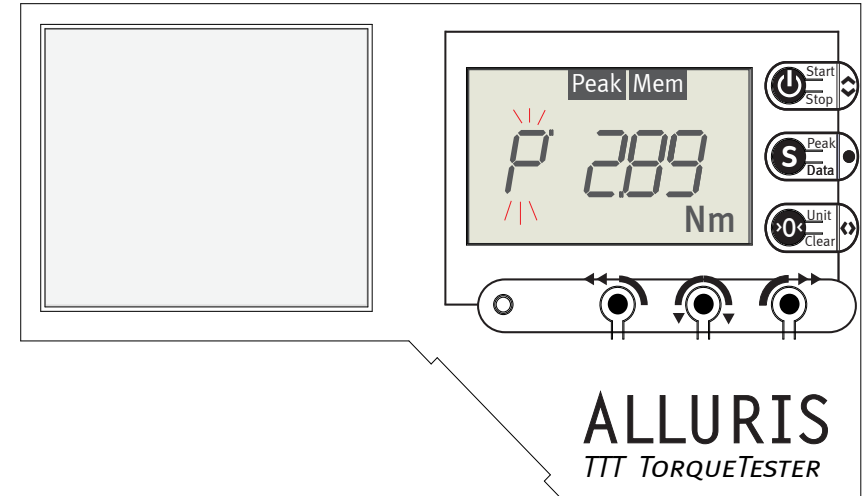

## 3.3. Overview



### USB 2.0 Mini-B-Socket

Function	Accessory part	Part number
Data analysis on PC	<a href="#">Software TTT_Certify</a>	TTT-930
Data transfer (e. g. to CAQ-Software)	<a href="#">TTT_Parameter-Check</a>	FMI-977
Data transfer auf PC	USB-Datenkabel	FMI-931USB

### Hirose-Buchse

Function	Accessory part	Part number
Trigger signals	<a href="#">Foot switch for data transfer</a>	FMT-936
Transfer of digital I/Os	<a href="#">Data cable for digital I/Os</a>	FMI-934SO

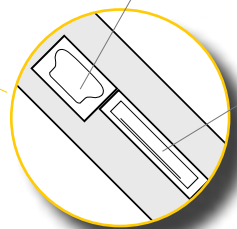



# TTT-300

Bedienungsanleitung  
 Operation manual  
 Notice d'utilisation  
 Instrucciones de servicio  
 Istruzioni per l'uso

## 3.4. Set-up functions

1	<b>Socket 3/8" square and 20 mm centering bolt</b>
2	<b>Solar cell</b> Collects energy even if the instrument is switched off.
3	<b>USB 2.0 Mini socket</b> for data transfer and also for charging the buffer battery after long storage in the dark
4	<b>15-pin Hirose socket</b> (for digital I/Os, service, calibration ecc.)
5	<b>Housing IP42</b> Protection given with closed cap over jacks (L= 280 mm B= 170 mm H= 95,3 mm)
6	<b>Display</b>
7	<b>Adapter</b> Male square 3/8" M 10 mm to female square 3/8" 10 mm Male square 3/8" M 10 mm to female square 1/4" 6,3 mm Male square 3/8" M 10 mm to male hex 5/16" 8 mm Male square 1/4" M 6,3 mm to male hex 5/32" 4 mm Male square 1/4" M 6,3 mm to male hex 1/4" 6,3 mm  More accessories for individual tasks see <a href="http://www.alluris.de">www.alluris.de</a>
8	<b>Threaded holes (M6) on the underside</b> with threaded bolt and knurled nut for table mounting

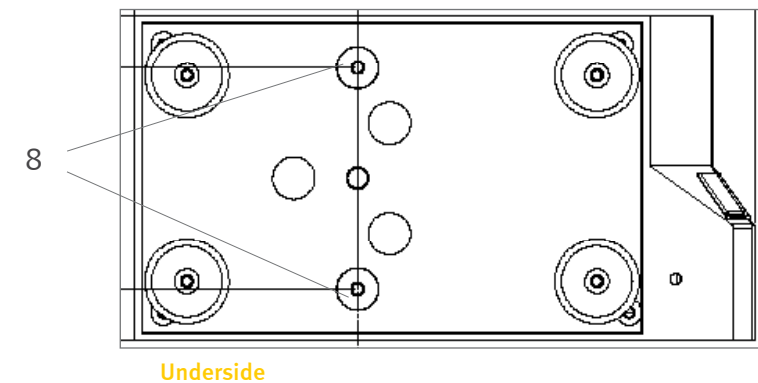
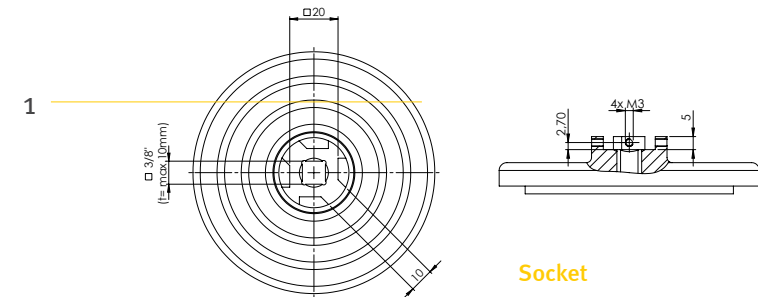

# TTT-300

Bedienungsanleitung  
Operation manual  
Notice d'utilisation  
Instrucciones de servicio  
Istruzioni per l'uso

## 3.5. Control panel

1	<b>LCD-Display</b> 4-digit display of measured values and measurement modes
2	<b>I-key</b> <ul style="list-style-type: none"><li>On/ Off (press 2 seconds)</li><li>Start/ Stop measurement</li><li>select next item in menus</li></ul>
3	<b>S-key</b> <ul style="list-style-type: none"><li>store data</li><li>show measuring results</li><li>enter / exit parameter menu (press 2 seconds)</li><li>apply changes in the parameter menu</li></ul>
4	<b>O-key</b> <ul style="list-style-type: none"><li>delete individual values</li><li>delete all values and reset to "idle" (press 2 seconds)</li><li>tare manually</li><li>in parameter menu: enter submenus</li><li>change measurement unit</li></ul>
5	<b>LED signal limit monitoring</b> active with plugged USB-cable, switches between <b>red</b> (= bad) and <b>green</b> (= good)
6	<b>Mode-button for measuring mode - Peak CCW</b> toggles between the measurement modes "Standard" and "Peak CCW" (counterclockwise). "Peak CCW" measures the torque peak in the counterclockwise direction (with drag pointer function).
7	<b>Mode-button for measuring mode - Peak-Actual-Value</b> toggels between the measurement modes "Standard" and "Peak Actual-Value" (actual measured value). The display shows a blinking "Peak" symbol .
8	<b>Mode-button for measuring mode - Peak CW</b> toggles between the measurement modes "Standard" and "Peak CW" (clockwise). "Peak CW" measures the torque peak in the clockwise direction (with drag pointer function).

Display und Funktionstasten

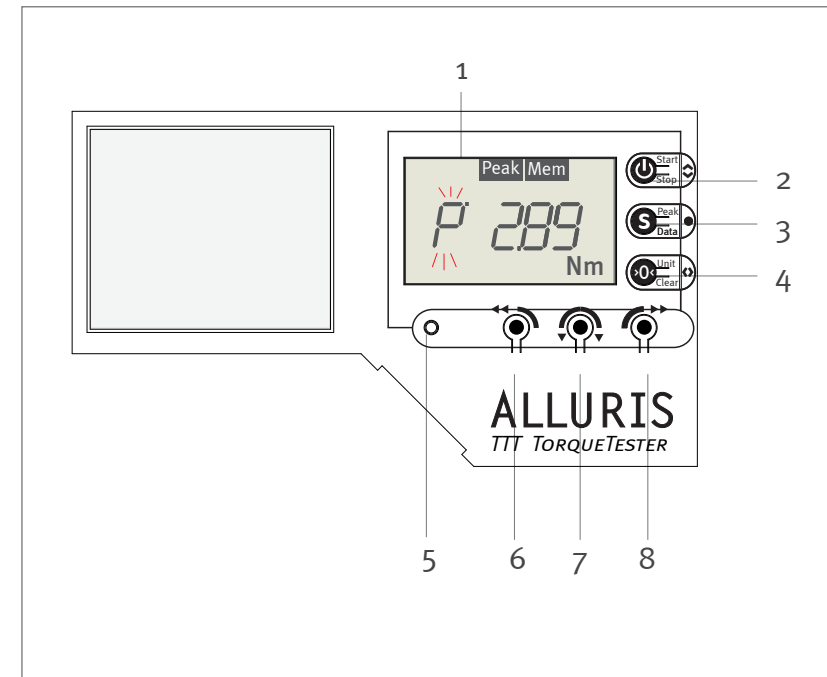

## 4.0 Starting Operation

### 4.1 Installation and connection

Remove the transport protection and place the instrument on a flat stable surface. The surface should be clean and free of grease.

For fixed positioning the device can be screwed as an additional safeguard against slipping with the bench (thickness up to 30 mm). For this purpose two holes and threaded bolts with knurled nuts are located on the bottom side.

The instrument requires no external power supply as a built-in solar cell supplies the necessary power.

The audible signal (buzzer) and LED signal only work if the device is connected to an external power supply. An universal power supply USB (FMI-946) can be ordered separately.

For data transfer to PC for measurement documentation or calibration, first install the software „TTT\_Certify“ (TTT-930) on the PC and then connect the USB data cable (FMI-931USB) to the USB socket.

If you want to trigger the data transfer via a foot switch, install the [TTT\\_Parameter-Check](#) (FMI-977) and connect the [foot switch for data transfer](#) (FMT-936) to the Hirose-socket.

For the digital transmission of status limit/overload and trigger signals etc. you need the appropriate [data cable for digital I/Os](#) (FMI-934SO).



# TTT-300

Bedienungsanleitung  
Operation manual  
Notice d'utilisation  
Instrucciones de servicio  
Istruzioni per l'uso

## 4.2. Inserting the test object

Make sure you choose the right adapter for the tool you want to check. **Additional adapters** can be found at [www.alluris.de](http://www.alluris.de).



Place the adapter in the socket. For motorized torque drivers you may use a run down joint simulator (TTT-910).



Pay special attention to the proper alignment of the test object as shown in the picture. The test axis of rotation must be perpendicular to the socket.



For measurements according to DIN EN ISO 6789 make sure that torque is applied within the admissible angular deviation from the axis of the tool. For standard-compliant calibrations according to ISO 6789, we recommend the installation of the tester in a test stand (TTT-920) (see p. 37, chapter 7.0 „Testing with test stand“).

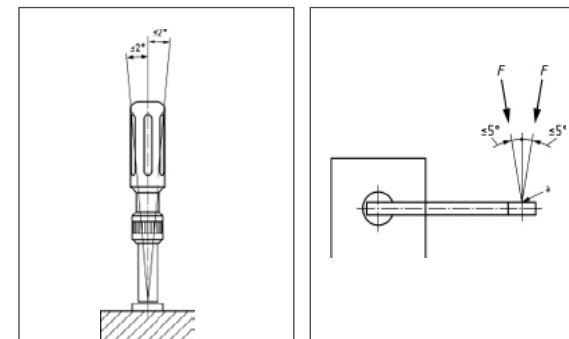

## 4.3. Turning the instrument ON/OFF

Turn on the instrument with the I-key. During a short self test three information displays appear consecutively in quick succession on the display. They show the device type, the date the next calibration is due and the nominal measuring range. Once the routine is completed the device is ready for use (idle).

At the start of each measurement an automatic tare is performed (see p. 13, chapter 4.3.1 „Changing measuring units“).

Pressing the I-key for two seconds you turn the instrument off.

After 5 minutes of inactivity the **auto-off function** turns off the instrument automatically, when no external power source is connected. You can adjust this period of time in parameter menu P15 (see p. 26, chapter 5.2.5 „Auto-Off function (instrument off) (P15)“).

### 4.3.1. Changing measuring units

The measuring unit is shown in the lower right corner of the display. A fast way to change the measuring unit is pressing the O-key when the instrument is idle. You can select either Nm (Default) or cNm as measuring unit.

Alternatively you may change the measuring unit via the parameter menu P11 (see p. 25, chapter 5.2.1 „Change measuring unit (P11)“).

Self test after turning on the instrument

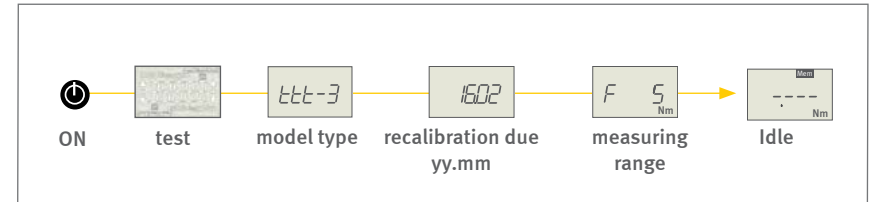

Changing the measuring unit

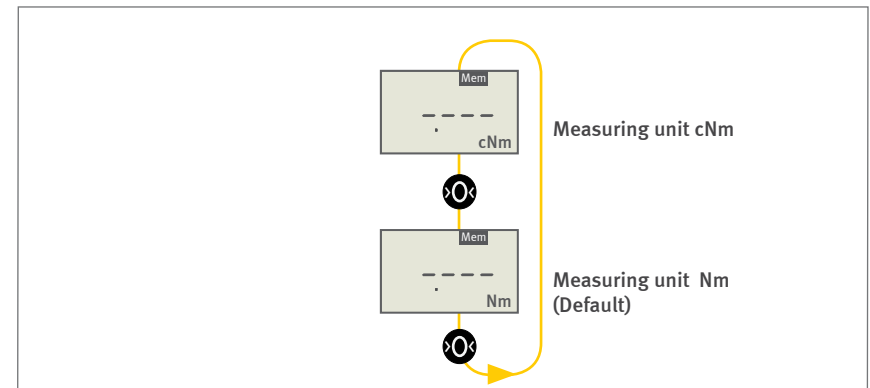

# TTT-300

Bedienungsanleitung  
Operation manual  
Notice d'utilisation  
Instrucciones de servicio  
Istruzioni per l'uso

## 4.4. Selecting the measuring mode

When the instrument is ready for use (idle) you can activate/deactivate different measuring modes with the directional keys:

- Standard (Default)
- Peak CCW (Counterclockwise)
- Peak Actual-Value
- Peak CW (Clockwise)

With the selection of a particular measurement mode, you determine

- which of the measured values should be shown (peak values or the currently measured value)
- in which direction
- with what frequency the instrument measures.

The instrument can automatically capture two peaks, the peak at triggering torque (click point) and the second maximum value.

### 4.4.1. Standard (Default)

If you have not selected any of the three peak modes, the instrument operates in the standard mode and always shows - when measuring - the current measured value. By default counter-clockwise measured torque values are shown as negative. You may change this setting (see p. 25, chapter 5.2.2 „Change prefix for CCW mode and CW mode (P12)“).

In this measurement mode the device measures with default frequency.

Directional keys for measuring mode selection

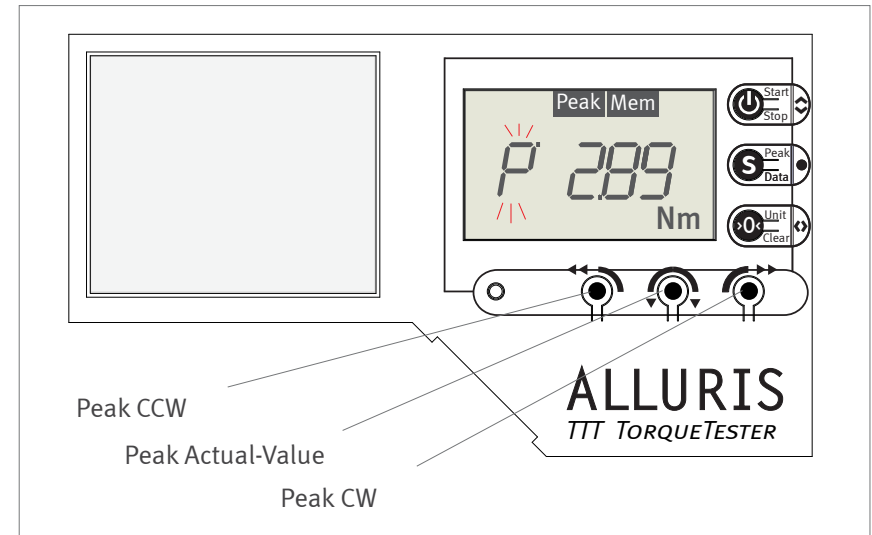

TTT-300 captures two peak values



## 4.4.2. Measuring mode: Peak CCW

In this measurement mode, the peak torque is measured and displayed while turning the test object counterclockwise (CCW). By default counterclockwise measured torque values are shown as negative. You may change this setting (see p. 25, chapter 5.2.2 „Change prefix for CCW mode and CW mode (P12)“).

If you turn the test object in the other direction - clockwise - , the values are not displayed.

The instrument captures two consecutive peaks, the triggering torque at click point and the second maximum value of torque tools (see p. 21, chapter 4.8.2 „View results in peak modes“).

The display corresponds to a drag indicator, which is further advanced only at increasing values. If the measurement values are decreasing, the display remains unchanged. You can reset the drag indicator during the measurement by pressing the O-key (see p. 19, chapter 4.7 „Reset the drag indicator“).

The following symbols on the display indicate that this measurement mode is active: the direction indicator moves counterclockwise and on the top edge of the screen appears a peak symbol.

The instrument measures with increased frequency (high-speed measurement with about 1 kHz).

## 4.4.3. Measuring mode: Peak Actual-Value

In this measurement mode, the current measured value (actual value) is displayed namely in both directions of rotation. By default counterclockwise measured torque values are shown as negative. You may change this setting (see p. 25, chapter 5.2.2 „Change prefix for CCW mode and CW mode (P12)“).

A flashing peak symbol at the edge of the display indicates that this measurement mode is active.

The instrument measures with increased frequency (high-speed measurement with about 1 kHz).

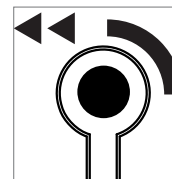

Directional key  
Peak CCW

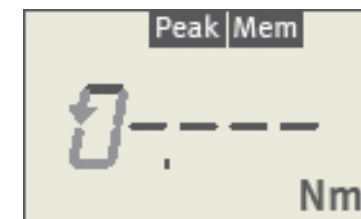

Instrument is ready for use in measuring mode Peak CCW.

On the left the indicator for the counterclockwise direction.



Directional key  
Peak Actual-Value

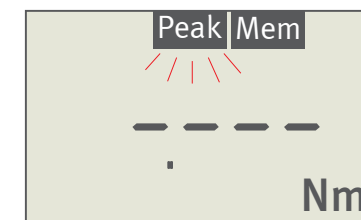

Instrument is ready for use in measuring mode Peak Actual-Value.

# TTT-300

Bedienungsanleitung  
Operation manual  
Notice d'utilisation  
Instrucciones de servicio  
Istruzioni per l'uso

## 4.4.4. Measuring mode: Peak CW

In this measurement mode, the peak torque is measured and displayed while turning the test object clockwise (CW). If you turn the test object in the other direction - counterclockwise - , the values are not displayed.

The instrument captures two consecutive peaks, the triggering torque at click point and the second maximum value of torque tools (see p. 21, chapter 4.8.2 „View results in peak modes“).

The display corresponds to a drag indicator, which is further advanced only at increasing values. If the measurement values are decreasing, the display remains unchanged. You can reset the drag indicator during the measurement by pressing the O-key (see p. 19, chapter 4.7 „Reset the drag indicator“).

The following symbols on the display indicate that the measurement mode is active: the direction indicator moves clockwise and on the top edge of the screen appears a peak symbol.

The instrument measures with increased frequency (high-speed measurement with about 1 kHz).



Directional key  
Peak CW

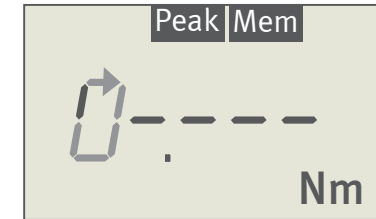

Instrument is ready for use in measuring mode Peak CW.

On the left the indicator for the clockwise direction.



## 4.5. Start/Stop measurements

Make sure the adapter fits the tool to be tested and insert the test object into the socket (see p. 12, chapter 4.2 „Inserting the test object“).

### Start:

Start the measurement by pressing the I-key. The display now shows shortly „tArA“, then according to the resolution or measuring unit „0.000“, „00.00“ or „0“. The unit symbol in the display starts flashing.

### Measuring:

The display shows the current measured value or the previously reached peak value is constantly displayed (see p. 14, chapter 4.4 „Selecting the measuring mode“). During the measurement, the unit flashes on the display.

If the instrument is connected to an external power source, a permanent tone signals when the current measured value / peak value is within pre-set limits. Otherwise you will hear an intermittent tone (see p. 26, chapter 5.2.7 „Buzzer - activating the signal tone (P17)“).

### Stop:

Pressing the I-Key again stops the measuring.

Storing a value during the measurement with the S-key stops the measurement as well.

Using the Auto-Stop-Function (see p. 25, chapter 5.2.4 „Auto-Stop - automatic measuring stop (P14)“) the measurement is stopped automatically when the measured value remains unvaried within a specified period of time.

After stopping the measurement, the measured value appears on the display. Depending on the selected measurement mode, this is either the last measured value or the respective peak. The unit symbol stops flashing.

Display during measurement

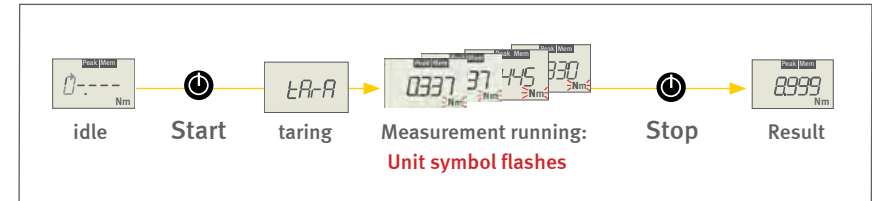

Display during measurement in Peak CW oder Peak CCW mode

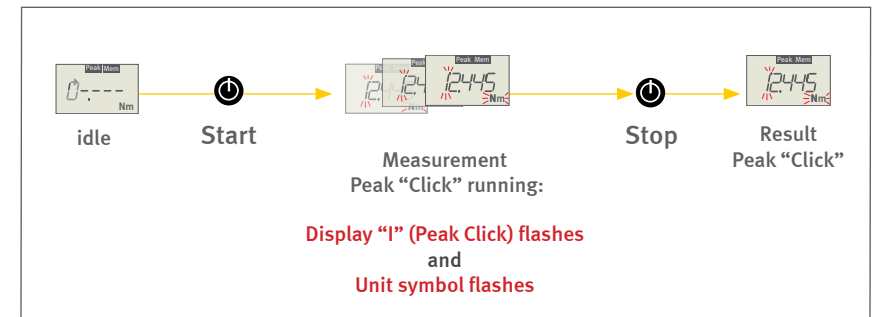

## 4.6. Quick-Check

The Quick-Check function allows to store five subsequent measurements automatically. The instrument measures and saves after starting a measurement both Peaks as usual. Then it sets back automatically the peak values after the chosen Auto-Stop-time and starts the next measurement. After five measurements the instruments stopps automatically.

The Quick-Check function is disabled at delivery of the instrument. Through parameter menu P22 you may activate or deactivate the function (see p. 29, chapter 5.4.4 „Activating Quick-Check (P22)“).

By activating Quick-Check the memory function is activated automatically and the **Mem** icon appears at the upper edge of the display.

Each one of the consecutive measurements is compared with the previously set limit values and stored. A bad result is shown as „bAd“ on the display and the status LED lights up red. You should then repeat the entire test sequence and possibly adjust your torque tool.

The function Quick-Check is independent of the software tool TTT\_Quick-Check. The software tool facilitates the adjustment of the limit values and the reading of the memory (see p. 34, chapter 6.1.2 „TTT\_Quick-Check“).

## 4.7. Taring

At the start of each measurement an automatic tare (auto-tare function) is carried out to compensate for the weight of the test piece and the occurring tension while applying force. In addition, there is an automatic compensation of the temperature drift.

As long as the instrument is taring the display shows „tArA“. Attention: Do not apply force during taring. Otherwise incorrect measurements may occur.

The auto-tare function can be switched off (see p. 26, chapter 5.2.6 „Auto-Tara - automatic taring (P16)“).

Due to the sensitivity of the instrument a value which is not zero may be displayed due to barely perceptible vibrations.

In the measurement modes **Standard** and **Peak Actual-Value** you can tare the instrument during the measurement by pressing the O-key.

## 4.8. Reset the drag indicator

When the measurement modes Peak CCW or PeakCW are set, you may reset the drag pointer function by pressing the O-key during an ongoing measurement. The instrument will not be tared but reset to the actual measured value. Both peak values will be reset at the same time and the measurement of the first peak restarts immediately.

Force application only after taring!

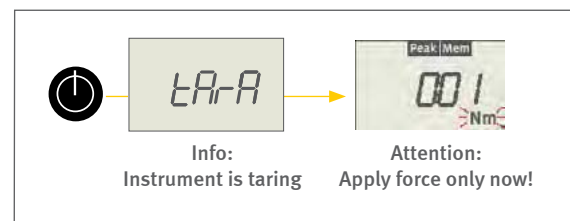

## 4.9. View readings

### 4.9.1. View readings in standard mode

In standard mode, the unit displays the current measured value. After stopping the measurement, the display shows the last measured value.

If you have activated the memory function before starting the measurement (see p. 28, chapter 5.4.2 „Activating the memory and statistics function“), you can view statistical values to the readings you have saved (grey area in the graph). The diagram shows the order in which the values are displayed on the screen.

Maximum - Highest Value of all stored values.

Minimum - Lowest Value of all stored values.

Average - arithmetic average of stored values

Variance - from average of stored values

To recall statistical values press the S-key after stopping the measurement. The first result will appear (see chart on the left). Use the S-key to scroll down through the items.

Standard-Modus with active memory:  
 Screen sequence of stored readings and statistical values

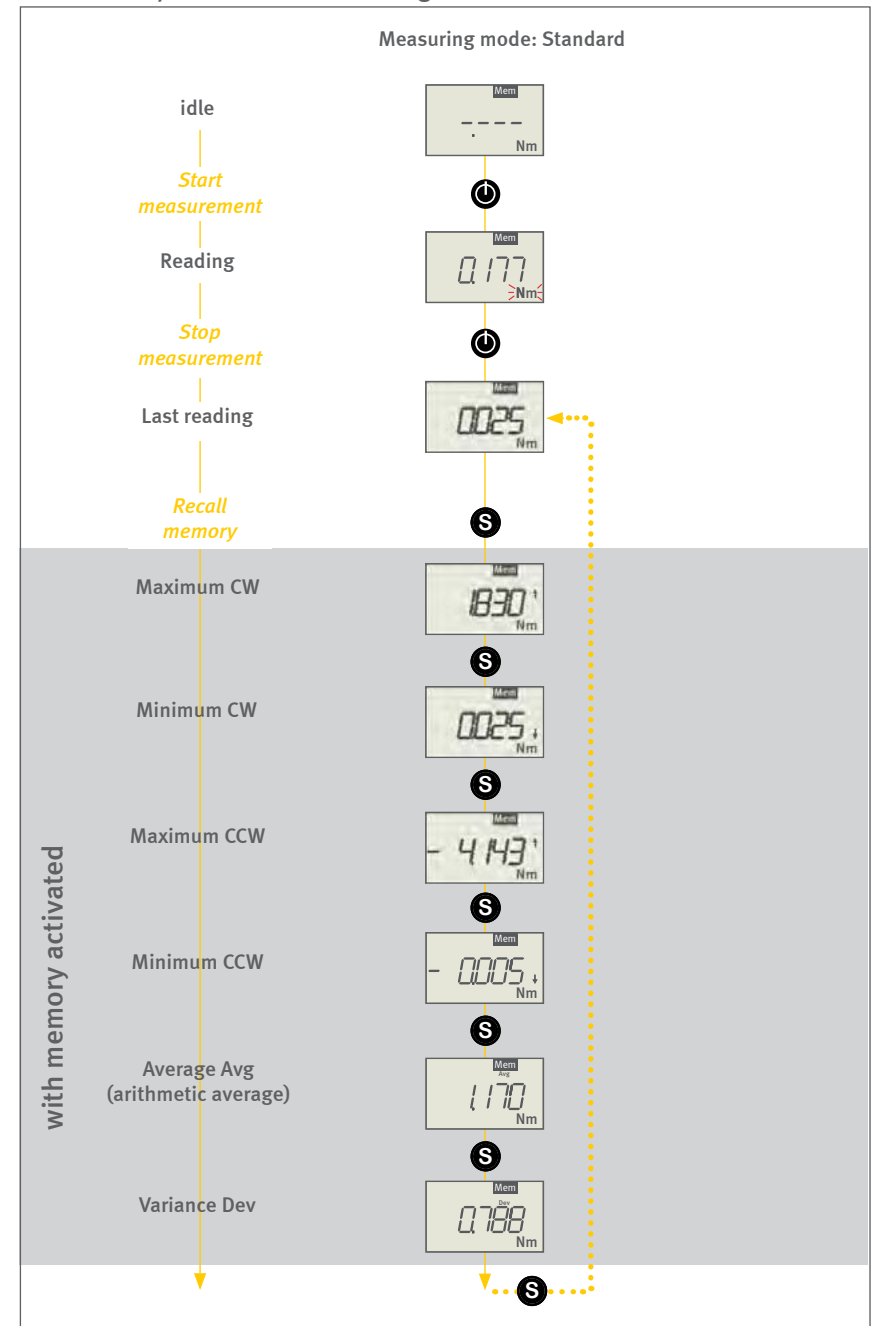

# TTT-300

Bedienungsanleitung  
 Operation manual  
 Notice d'utilisation  
 Instrucciones de servicio  
 Istruzioni per l'uso

## 4.9.2. View results in peak modes

In peak modes **Peak CCW** and **Peak CW** the instrument captures first the peak torque value at the click point (Peak Click). In the background it detects the peak value after the click (Peak 2).

After stopping the measurement the display shows Peak Click.

You can recall the two peak values and statistical values by pressing the S-key. The display shows the first memorized value as shown in the diagram. Use the S-key to scroll down the items in a fixed loop sequence as shown: first the four statistical value for Peak Click, then the statistics for Peak 2.

Press the I-Key to start a new measurement. With the start of a new measurement the peak values are reset.

Screen sequence of stored readings and statistics

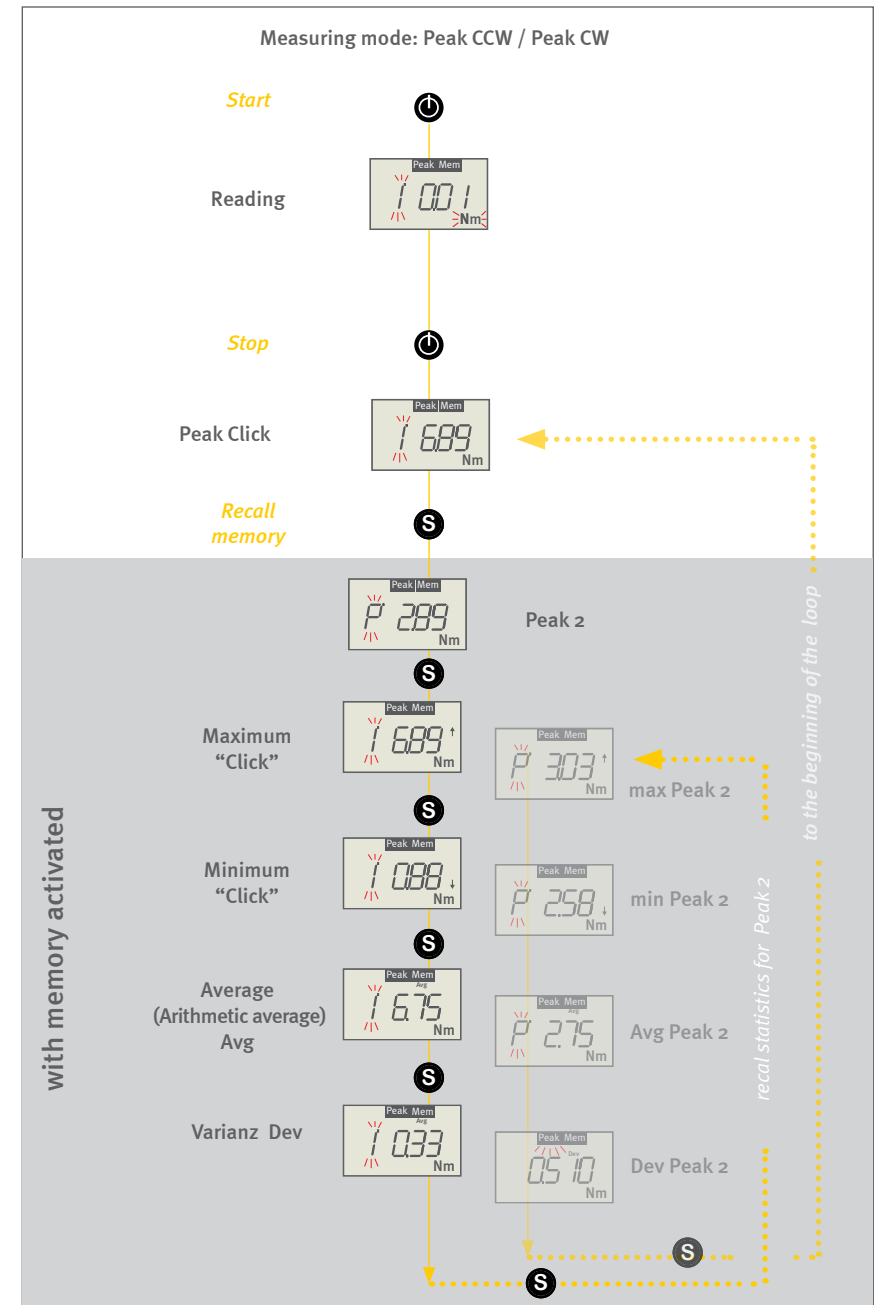

## 4.10. Clear data

You may delete the memory content selectively or completely with the O-key.

Any stored readings in the memory may be deleted individually by pressing the O-key. After that the display will show "0.00", „00.00“ or „0“.

The Peak Click and Peak 2 will be deleted simultaneously.

Statistical values cannot be deleted individually.

Press the O-key for two seconds to delete all stored values (values and statistics) at the same time.

The idle-display will appear as soon as the memory is cleared completely.

### Deleting values **individually**

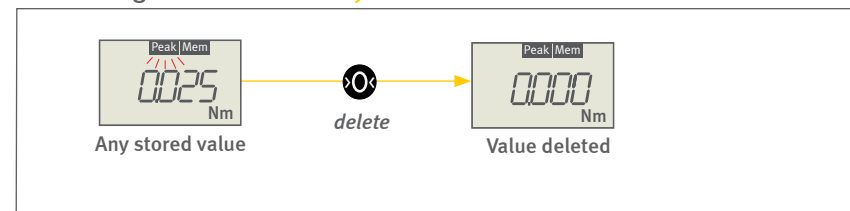

### Clear **memory** completely



## 5.0 Setting Measurement Parameters

### 5.1. Parameter Menu

The instrument's basic functions and parameters are configured through the parameter menu.

The instruments offer a memory and statistical function as well as a monitoring function with limit values. These functions can be activated and adjusted via the parameter menu.

When the instrument is ready for use (idle), call with a long press on the S-key the parameter menu. In the same way you revert from any point in the parameter menu to the operation mode.

The parameter menu offers eight submenus as indicated below. With the I-key you can scroll down through the items. Enter a menu with the O-key.

- P1** General Settings  
(see p. 24, chapter 5.2 „General settings (P1)“)
- P2** Memory and Statistics function  
(see p. 28, chapter 5.4 „Memory and Statistics function (P2)“)
- P3** Monitoring - Upper limit  
(see p. 31, chapter 5.5 „Monitoring limit values (P3 bis P6)“)
- P4** Monitoring - Lower limit  
(see p. 31, chapter 5.5 „Monitoring limit values (P3 bis P6)“)
- P5** Upper Limit for Peak 2  
(see p. 31, chapter 5.5 „Monitoring limit values (P3 bis P6)“)
- P6** Lower Limit for Peak 2  
(see p. 31, chapter 5.5 „Monitoring limit values (P3 bis P6)“)
- P7** Threshold for start of Peak 2-Measuring  
(see p. 33, chapter 5.6 „Threshold for start of 2nd peak measurement“)
- P0** Reset to Factory Defaults  
(see p. 27, chapter 5.3 „Reset to factory defaults (P0)“)

### Accessing parameter menu

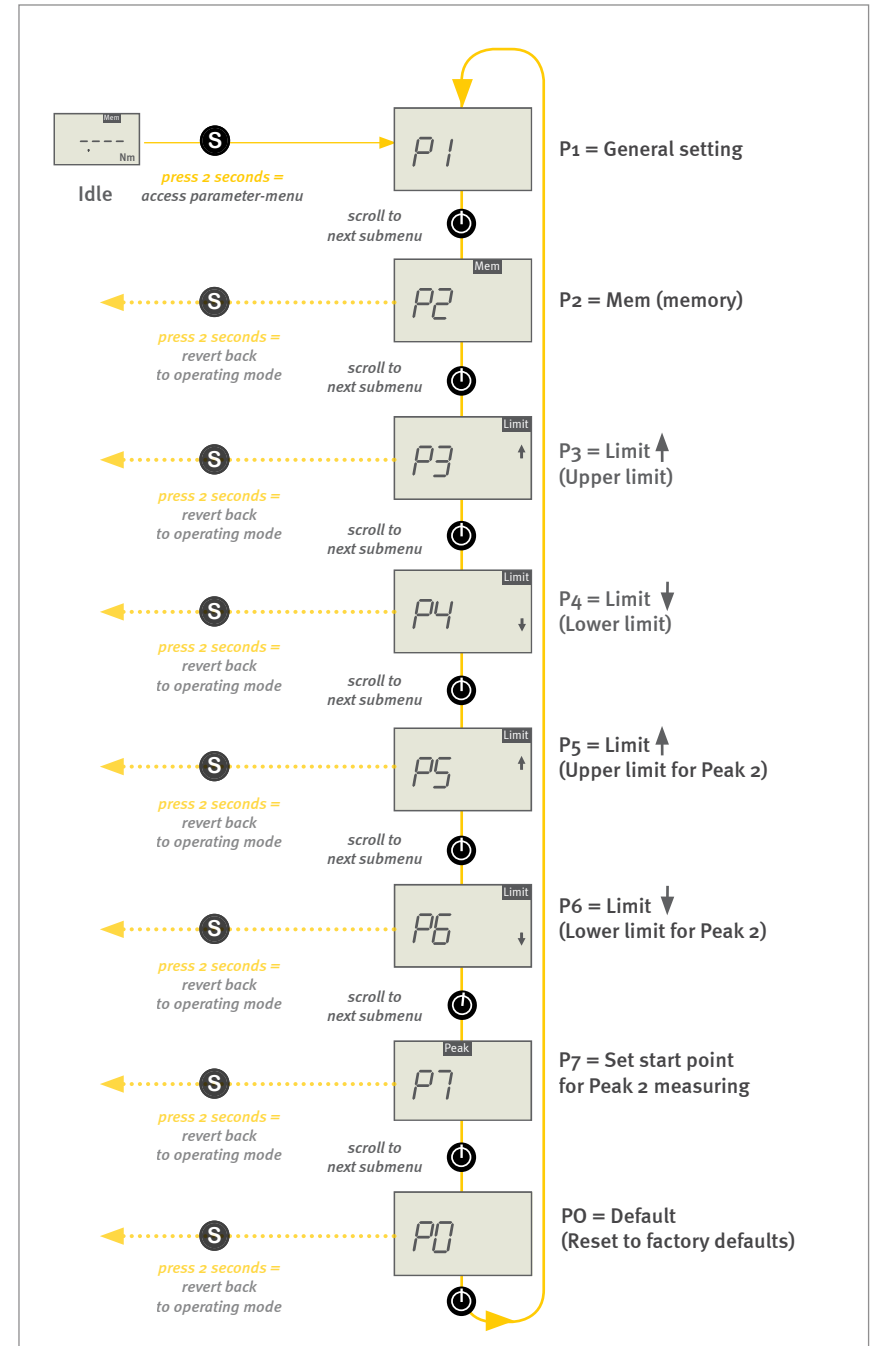

## 5.2. General settings (P1)

With menu P1 „General settings“ you may adjust the main features and settings of the Tool Torque Tester TTT.

The following submenus are available:

- P11 Change measuring units
- P12 Change +/- prefix
- P13 Display-Refresh-Rate
- P14 Automatic Measuring-Stop (Auto-Stop)
- P15 Auto-Off function (instrument off)
- P16 Automatic Taring (Auto-Tara)
- P17 Select/Deselect Buzzer

With the O-key you scroll through the submenus offered in menu P1. Enter a menu with the I-key.

In all submenus you may toggle with the I-key between the offered parameter settings. The actual selection flashes.

To select the parameter you may either press the S-key and revert at the same time one step back in the menu hierarchy or press the O-key to select the next submenu.

Press for 2 seconds the S-key to revert back to the operation mode.

Enter submenus in P1

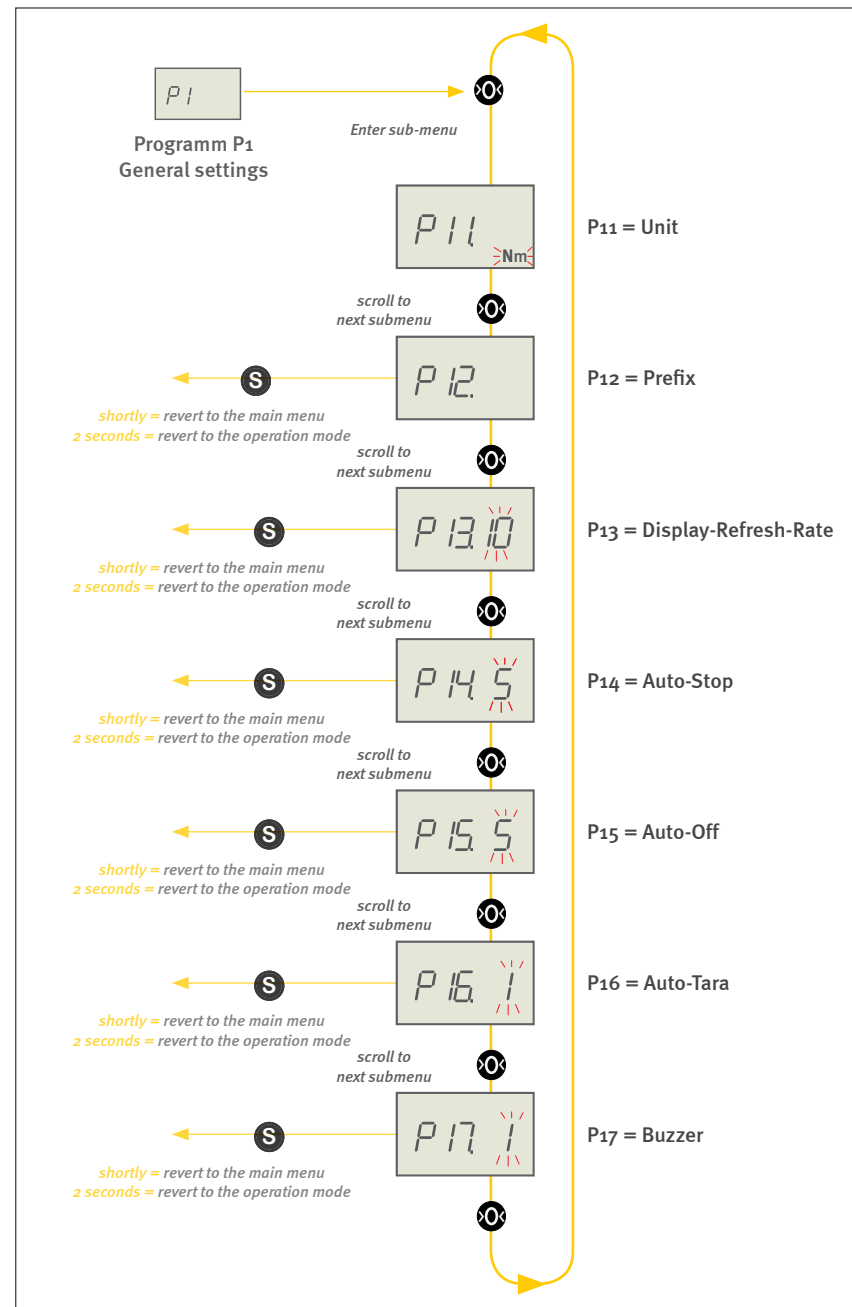



## 5.2.1. Change measuring unit (P11)

The SI unit newton metres (Nm) is the default setting. The measuring unit can be adjusted through submenu P11. Select the desired unit with the I-key. The active selection flashes on the display.

[Measuring-Unit: Nm - cNm ]

Press for 2 seconds the S-key to revert back to the operation mode.

## 5.2.2. Change prefix for CCW mode and CW mode (P12)

Torques acting counterclockwise to the measuring object are by default shown as negative readings and clockwise measurement values accordingly as positive. The prefix may be changed in submenu P12. Select the desired prefix with the I-key.

[Clockwise ( ) - Counterclockwise (-)]

Press for 2 seconds the S-key to revert back to the operation mode.

## 5.2.3. Display-refresh rate (P13)

The internal sensor captures torques with a maximum frequency of 3,6 kHz. To ensure the legibility of the display the display-refresh rate is limited by default to 10 Hz. Submenu P13 allows to reduce this value further. Press the I-key to select the desired frequency rate.

[Update-frequency: 1 - 2 - 3 - 5 - 10 Hz]

Press for 2 seconds the S-key to revert back to the operation mode.

## 5.2.4. Auto-Stop - automatic measuring stop (P14)

Measurements are stopped automatically when the measured values are stable for 5 seconds. Submenu P14 allows to adjust this period of time.

[Auto-Stop after: 2 - 5 - 10 - 20 - 30 Sekunden]

Press for 2 seconds the S-key to revert back to the operation mode.

### Example changing parameters: P13 - Display-refresh-rate

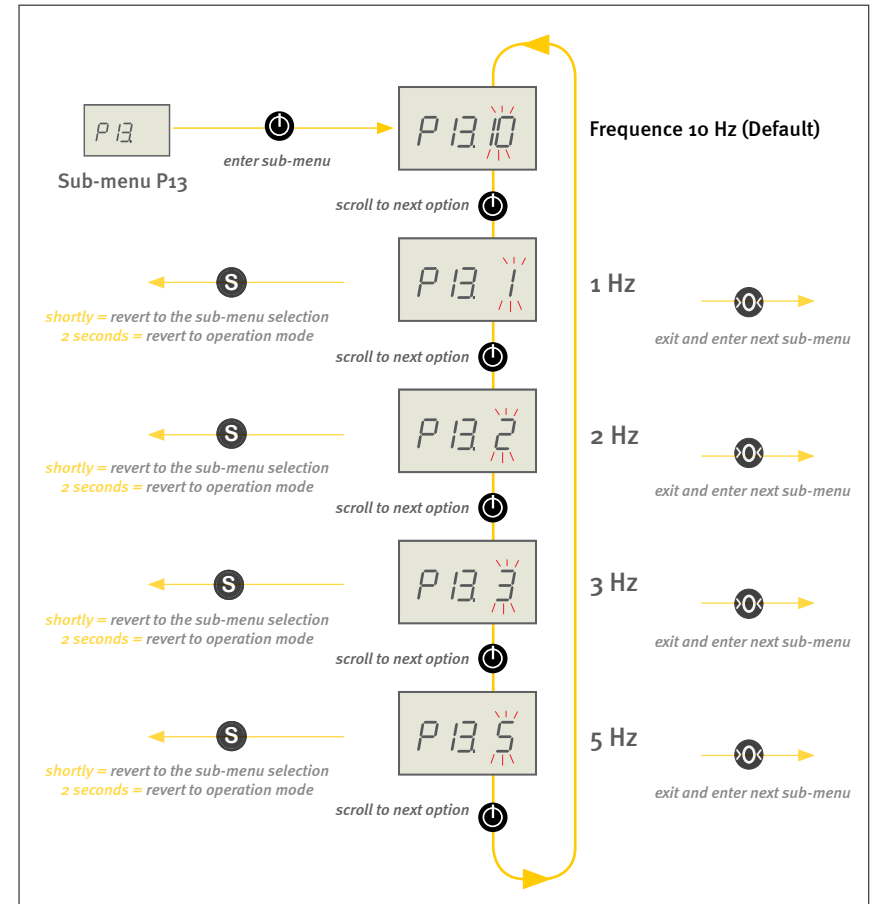

The selected option flashes

## 5.2.5. Auto-Off function (instrument off) (P15)

Cap torque testers CTT running without USB cable are turned off automatically, if no key is pressed for more than five minutes. Submenu P15 allows to adjust this period of time by pressing the I-key.

[Auto Off after: 1 - 2 - 3 - 5 - 10 - 30 - 60 - 90 minutes]

Press for 2 seconds the S-key to revert back to the operation mode.

## 5.2.6. Auto-Tara - automatic taring (P16)

Instruments are taring automatically when starting a measurement (auto-tare function) to compensate for the weight of the test object and the occurring tension while applying force. In addition, there is an automatic compensation of the temperature drift (see p. 19, chapter 4.7 „Taring“).

Submenu P16 allows to deactivate this function. Select „0“ with the I-key to deactivate the auto-tara function.

[Auto-Tara: 1 = ON - 0 = OFF]

Press for 2 seconds the S-key to revert back to the operation mode.

## 5.2.7. Buzzer - activating the signal tone (P17)

The instruments can support limit value monitoring with acoustic signals. The audible signal (buzzer) is activated once the device is connected to an external power supply (universal power supply USB (FMI-946)). While measuring a steady tone sounds as long as the measured value is within the defined limit values. Once the limits are exceeded or not reached, the buzzer changes to an interrupted tone.

Menu P17 allows to turn off the beep. Select „0“ with the I-key to deactivate the buzzer.

[Buzzer: 1 = ON - 0 = OFF]

Press for 2 seconds the S-key to revert back to the operation mode.

## 5.3. Reset to factory defaults (PO)

Submenu PO allows to reset all settings to factory defaults. Select menu PO and press the O-key to enter the menu. The display shows PO1 and a flashing „0“ (= no reset). By pressing the I-key you can select „1“ (= reset). Confirm by pressing the S-key and all settings are reset to factory defaults. The display shows shortly „rESEt“.

If you decide not to reset the settings after having chosen „1“, select again „0“ by pressing the I-key and return to the operation level by pressing the S-key.

[Reset factory defaults: 0 = no Reset - 1 = Reset]

### Werkseinstellungen

Type	Parameter	Default-Value
TTT-300	Unit	Nm
	Prefix	Clockwise CW (no prefix shown)
	Display-refresh rate	10 Hz
	Auto-Stop	5 secs
	Auto-Off	5 min
	Auto-Tara	ON
	Acoustic signal (Buzzer)	ON
	Memory	OFF
	Measuring mode	Standard
	Limit values	all 0
	Threshold for start of Peak 2 measuring	75 % drop from Peak Click

### Reset factory defaults

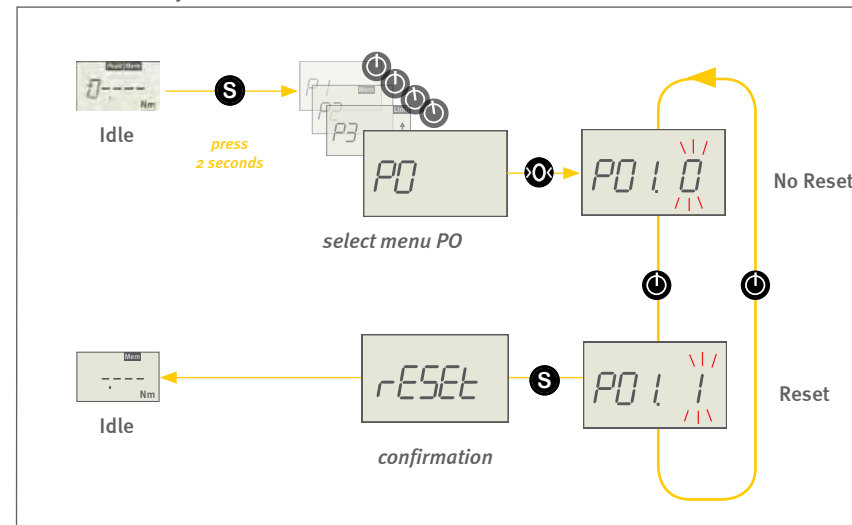

## 5.4. Memory and Statistics function (P2)

### 5.4.1. General explanation of the memory function

Tool Torque Tester TTT can store individual readings and show the results of simple statistical functions - maximum, minimum, average and deviation. Statistics are calculated for the data presently in memory.

Calculation of the variance:

$$DEV = \frac{1}{n-1} \sum_{i=1}^n (x_i - \bar{x})^2$$

For calibration of torque tools and the documentation of measurements you need to install TTT\_Certify (TTT-930) on your PC. This allows the calibration and printout of calibration certificates according to the standard.

All memories are cleared when you turn the instrument off.

### 5.4.2. Activating the memory and statistics function

The memory and statistics function is disabled at delivery of the instrument. Through parameter menu P2 you may activate or deactivate the function for storing individual values.

Press the 0-key to enter submenu P21 and select the desired storage function with the I-key:

**0** = no memory (Default)

**1** = memory active

Once the storage and statistics function is activated, the **Mem** icon appears at the upper edge of the display.

Press for 2 seconds the S-key to revert back to the operation mode.

Activate the memory and statistics function

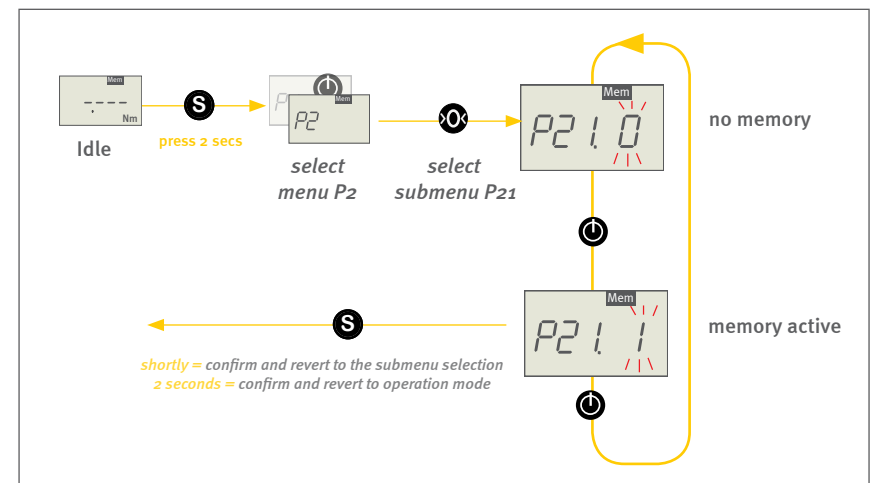

### 5.4.3. Storage of single values (P21)

The Instrument saves after every measurement Peak Click and Peak 2. You may display both values after the measurement by pressing the S-key.

Having activated the memory function (**Mem**) before, you can save a single value by pressing the S-key during an ongoing measurement. The measurement will stop and the stored value is displayed. This procedure can be repeated up to 500 times.

The stored measured values are appended to already existent stored values.

### 5.4.4. Activating Quick-Check (P22)

The Quick-Check function allows to store five subsequent measurements automatically. The instrument measures and saves after starting a measurement both Peaks as usual. Then it sets back automatically the peak values after the chosen Auto-Stop-time and starts the next measurement. After five measurements the instrument stops automatically.

The Quick-Check function is disabled at delivery of the instrument. Through parameter menu P22 you may activate or deactivate the function.

To activate the Quick-Check function the memory function has to be activated too. By activating Quick-Check the memory function is activated automatically and the **Mem** icon appears at the upper edge of the display.

Press the O-key to enter submenu P22 and select the desired storage function with the I-key:

0 = no memory (Default)

1 = memory active

Press for 2 seconds the S-key to revert back to the operation mode.

Activate Quick Check

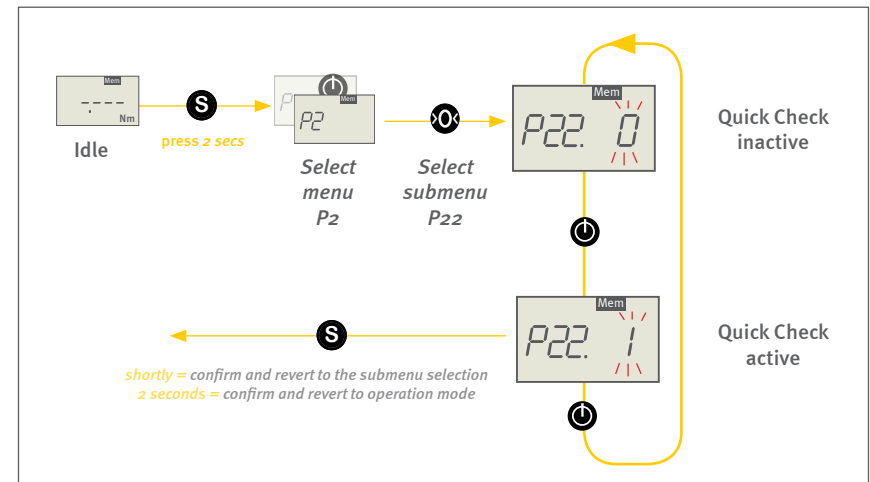

# TTT-300

Bedienungsanleitung  
Operation manual  
Notice d'utilisation  
Instrucciones de servicio  
Istruzioni per l'uso

## 5.4.5. View statistics

You may view, after having finished the measurement, the statistical results on the display pressing the S-key (see p. 20, chapter 4.9 „View readings“).

For more comprehensive testing and calibrating torque tools you may install the software TTT\_Certify (TTT-930) on your PC. The instrument has to be connected to the PC during measurements.

## 5.4.6. Clear memory

You have these ways to clear the memory:

- Hold down the O-key until the idle symbol appears on the display, to clear all data (statistics and measurements) from the memory at the same time.
- By turning the equipment off the entire memory contents (statistics and measurements) will be deleted.

The idle symbol appears on the display when no more values and statistics are stored in the device.



The idle symbol appears when memory is cleared

## 5.5. Monitoring limit values (P3 bis P6)

With the Tool Torque Tester TTT the current measured value can be compared with previously set upper and lower limits. Exceeding values or values below these thresholds are signaled on the display. In addition, a buzzer sound is emitted and a signal output is switched accordingly. To use the outputs, a corresponding cable (FMI-934SO) is needed. After the measurement a green/red LED signal indicates whether the measurement has passed or failed.

The limit function replaces the overload function of the instrument (provided the set limit value does not exceed the admissible overload).

### 5.5.1. Working with the limit value (threshold) function

If a limit value is set (at least one of the limit values is uneven zero) the limit function is activated and the display shows the **Limit** symbol. As long as the measured value is below the lower limit value a downward pointing arrow is shown on the right side of the display. Accordingly an upward pointing arrow is shown if the measured value surpasses the upper limit value. No arrow appears if the measured values are within the limits.

Once the limit value monitoring is enabled and an external power supply is connected, also the acoustic signal is activated. A continuous tone signals during the measurement, that the currently measured value is within the limits. If the values are above or below the upper or lower limit, the tone changes to a discontinuous sound. You can turn off the acoustic signal (see p. 26, chapter 5.2.7 „Buzzer - activating the signal tone (P17)“).

Visually, the limit value monitoring is supported by the LED indicator, if an external power supply is connected. After a measurement a green light indicates that the measured values were within the limits. The light is red if the measured values were above or below the limits.

In the operating modes **Peak CCW** and **Peak CW**, after a measurement „bAd“ appears on the display, if one of the two peak values is out of limits (when using the Quick Check function: after the cycle of five measurements, if this was true for one of the five measurements).

Monitoring limit values

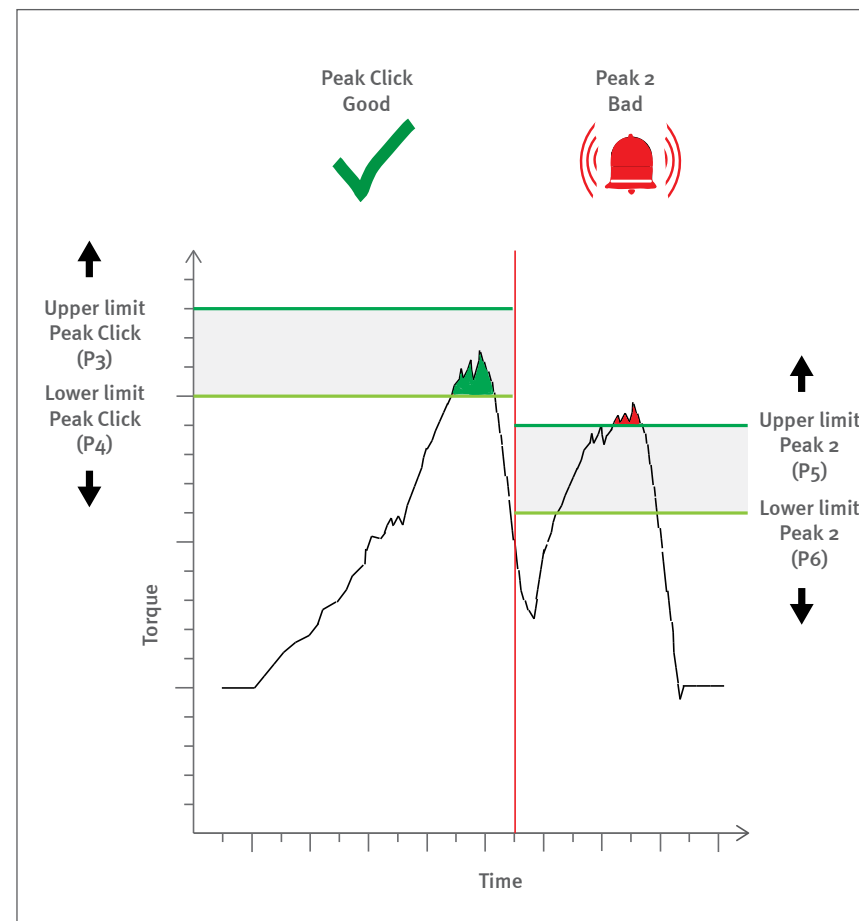

# TTT-300

Bedienungsanleitung  
 Operation manual  
 Notice d'utilisation  
 Instrucciones de servicio  
 Istruzioni per l'uso

## 5.5.2. Setting limit values

Limits are set comfortable with the software TTT\_Certify and TTT\_Quick-Check on your PC.

You may also set limits through the parameter menus P3 for the upper limit and P4 for the lower limit of Peak Click. For Peak 2 you may set limits separately: through menu P5 the upper limit and through P6 the lower limit.

Five digits appear on the display. A sixth digit is the prefix digit on the extreme left. By default no prefix is shown.

To enter limit values, the four digits from the right are available. The first digit is visible but not enabled in the limit monitoring menus P3 to P6. Scroll with the O-key through the digits to select the digit you want to change. The currently active digit flashes. Then set the desired value with the I-key. Each press will increment by one.

By pressing the S-key you save the values and return to the parameter menu.

## 5.5.3. Delete limit values

You delete limit values by setting new values as described above. If all values are set to zero the limit value function is deactivated.

A reset of the instrument to factory defaults also resets the limit values. Whereas turning the instrument off or clearing all data from the memory does not delete limit values.

Display in in limit value menus

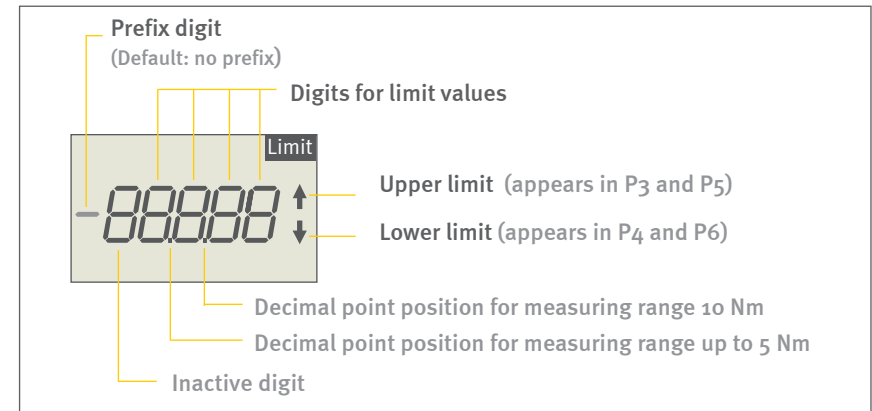

Example: Setting limit values (P3)

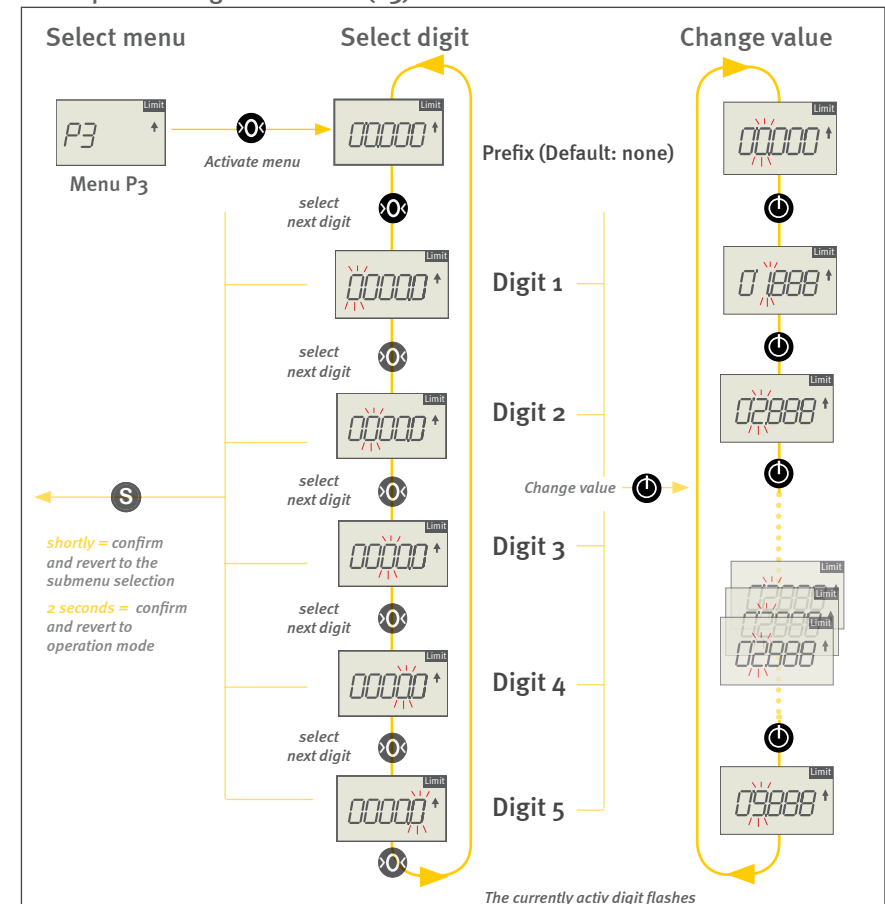

The currently activ digit flashes



## 5.6. Threshold for start of 2nd peak measurement

Through menu P7 you can define at which point the instrument starts measuring the second peak. This threshold is defined as percentage of the Peak Click value.

By default the Peak 2 measurement starts at a drop to 75 % of the Peak Click value (see chart). You can change this value in 5 % increments (in the range up to 90 %) and in 1 % increments (over 90 %) to adapt to different applications (see dashed curves).

The curve is very much dependent on the respective torque wrench and the test speed (sensitivity) of the respective user. To determine the optimal settings, you can use the included software tool TTT\_Parameter check (see p. 35, chapter 6.1.3 „TTT\_Parameter-Check“).

Below 1 % of the instrument's maximum measuring range the passing on to the second peak will not be activated. That way an erratic start of the 2nd peak measurement by shaky curves at the start of the readings is inhibited.

[Start measuring 2. Peak at: 5-10-15-20-25-30-35-40-45-50-55-60-65-70-**75**-80-85-90-91-92-93-94-95-96-97-98-99 %]

Varying the threshold for starting the measurement of Peak 2.

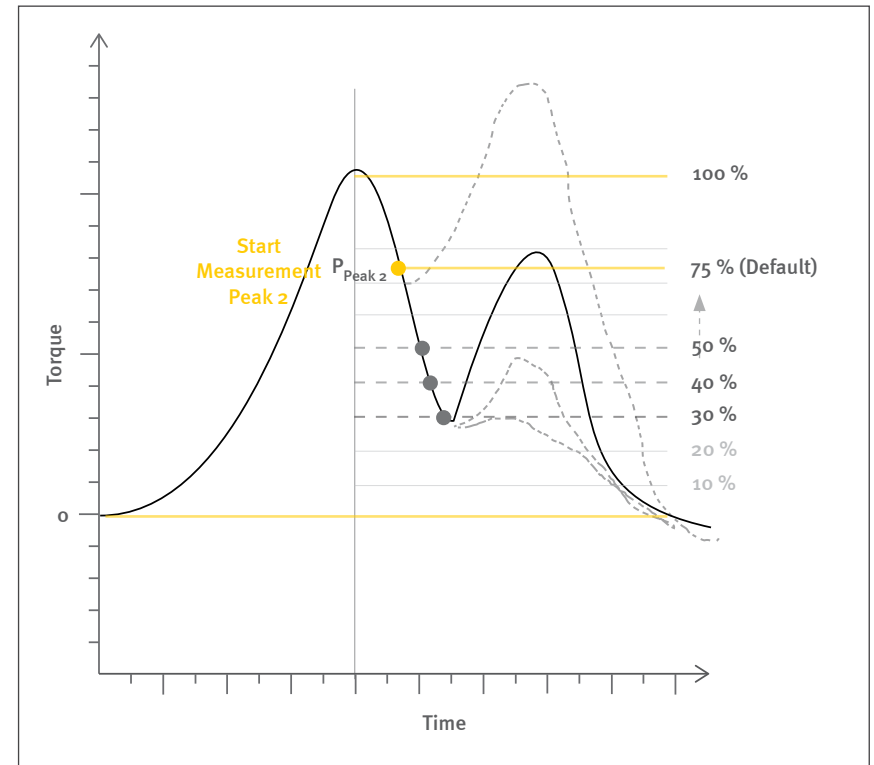

# TTT-300

Bedienungsanleitung  
Operation manual  
Notice d'utilisation  
Instrucciones de servicio  
Istruzioni per l'uso

## 6.0 Data transfer

The Tool Torque Tester TTT can transfer measurement data and incidents such as „limit value exceeded“ or „overload“ via USB (2.0) or Hirose cable to a PC.

### 6.1. Data transfer via USB

For data transfer via USB an appropriate cable (FMI-931USB) and software with device driver is required.

#### 6.1.1. Software TTT\_Certify

The software TTT\_Certify (TTT-930) allows standardized calibration of torque tools according to DIN EN ISO 6789, with or without repetitions when surpassing the allowable deviation.

The software can create a calibration certificate subsequently to the measurements. To simplify the calibration tester and tool should be mounted in a test stand (see p. 37, chapter 7.0 „Testing with test stand“). Precondition for creating the calibration certificate is that the tester itself has a valid calibration certificate, which will be stored in the instrument.

#### 6.1.2. TTT\_Quick-Check

Quick-Check enables quick execution of five successive measurements with parameter setting and visualization on the PC. The instrument captures and stores two peaks after starting the measurement, sets back the peaks after the set Auto-Stop-time automatically and starts the next measurement. After five measurements the instrument stops automatically.

Software TTT\_Certify

Prüfmitel	Seriennummer	Hersteller	Modell	Typ	M. max	
001	X1	12345	Stahlwelle	730N2	IA	10,00
002	B1	S44780	PROXXON	MicroClick MC 320	IA	320,00
003	C1	XZK44	PROXXON	MicroClick MC 5	ID	5,00
004	12x k	9982	ZEMO	M-34 Nm R855285	IA	34,00
005	9-34	2345	GEDORE	Typ83	IB	4,00
006	123	SN15-492285	Garant	65 6050_6	IA	6,00

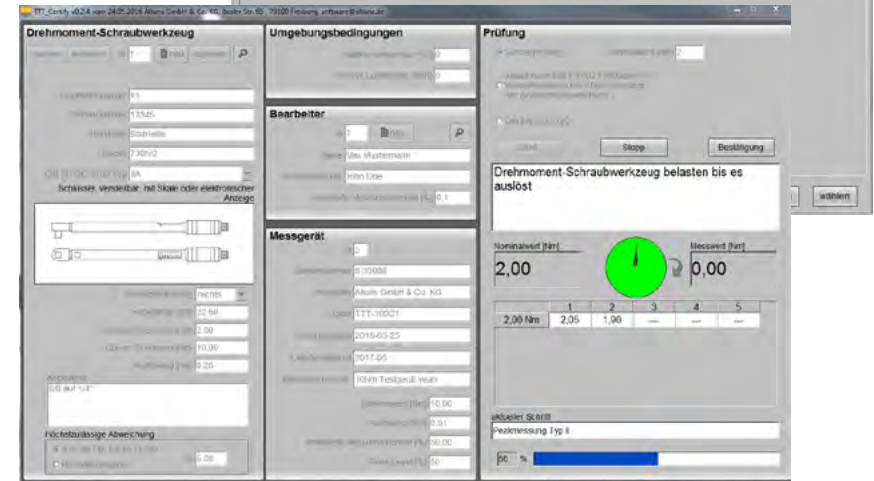

Screenshot evaluation protocol and selection of test equipment

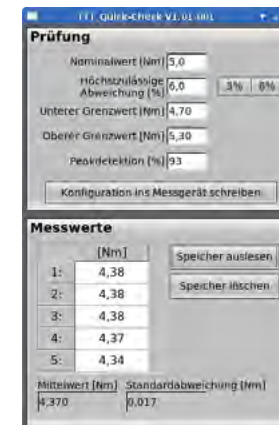

TTT\_Quick-Check screenshot

# TTT-300

Bedienungsanleitung  
 Operation manual  
 Notice d'utilisation  
 Instrucciones de servicio  
 Istruzioni per l'uso

## 6.1.3. TTT\_Parameter-Check

As curves in peak detection may vary depending on the triggering behavior of a torque tool, the supplied software tool TTT\_Parameter-Check helps to determine the right parameters for peak detection (see p. 33, chapter 5.6 „Threshold for start of 2nd peak measurement“).

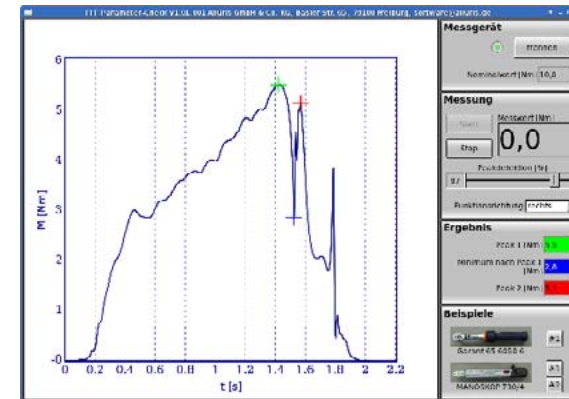

TTT\_Parameter-Check screenshot

## 6.1.4. Software COM-Bridge (from quarter 04/2016)

The software COM-Bridge allows direct data transfer from the tester with USB interface to PC applications with RS232 interface.

Data transfer can be configured to be carried out via the S-key on the instrument or an external foot switch. In the latter case connect a foot switch for data-transfer (FMI-936) with Hirose connector to the Hirose-socket.

## 6.2. Hirose socket

The Cap Torque Tester CTT have a 15-pin Hirose socket for several extension options and service functions.

### 6.2.1. Foot switch for data transfer

You may connect a foot switch with Hirose connector (part no.: FMI-936) to initiate data transfer. Combined with the software COM-Bridge data are easily transferred to PC applications such as CAQ software. The foot switch needs no additional power supply.

Length of cable: app. 3 m.

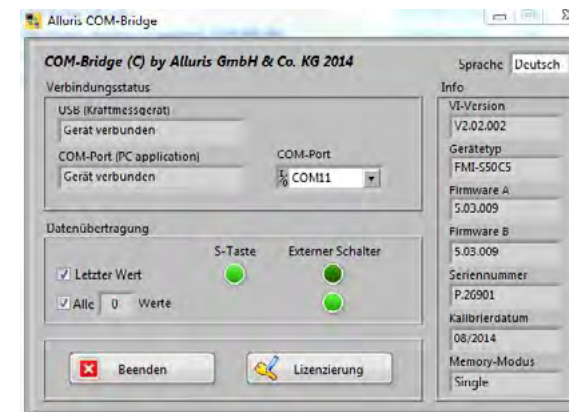

COM-Bridge screenshot

## 6.2.2. Data cable for digital I/Os

The cable with Hirose-socket (FMI-934SO) allows:

- 3VDC power supply
- Digital input
- Digital output/overload output

### Cable assignment at wire end

	Color	Assignment	Function
1	Weiss / White	Supply 3VDC	3VDC supply
2	Braun / Brown	GND	
3	Grün / Green	DIGIN <sub>1</sub>	Digital input
4	Gelb / Yellow	TRIGGER_OUT(C)	Trigger signal measuring frequency
5	Grau / Grey	TRIGGER_OUT(E)	
6	Orange / Orange	DIGOUT <sub>1</sub> (C)	Digital output
7	Blau / Blue	DIGOUT <sub>1</sub> (E)	
8	Rot / Red	DIGOUT <sub>2</sub> (C)	
9	Schwarz / Black	DIGOUT <sub>2</sub> (E)	
10	Violett / Violet	DIGOUT <sub>3</sub> (C)	
11	Schwarz-Weiss / Black-White	DIGOUT <sub>3</sub> (E)	
12	Rot-Weiss / Red-White	LIMIT_MAX(C)	Digital limit/overload output
13	Weiss-Grün / White-Green	LIMIT_MAX(E)	
14	Braun-Weiss / Brown-White	LIMIT_MIN(C)	
15	Weiss-Gelb / White-Gelb	LIMIT_MIN(E)	

### Input:

Input voltage  $U_{in} = 3...24\text{ V}$  (positive logic)

Internal resistance  $R_i = 10\text{ k}\Omega$

### Output:

Collector voltage  $U_{CE} \leq 40\text{ V}$

Collector current  $I_C \leq 40\text{ mA}$

Total power  $P \leq 350\text{ mW}$

(E.g. max. operating points: 5 V@40 mA; 12 V@29 mA; 24 V@14 mA)

### Connecting the digital outputs

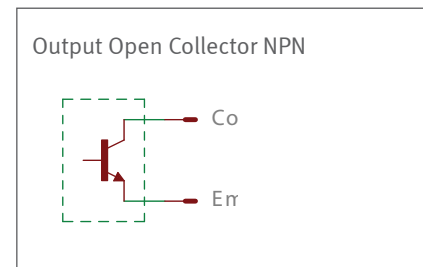

### Connection example

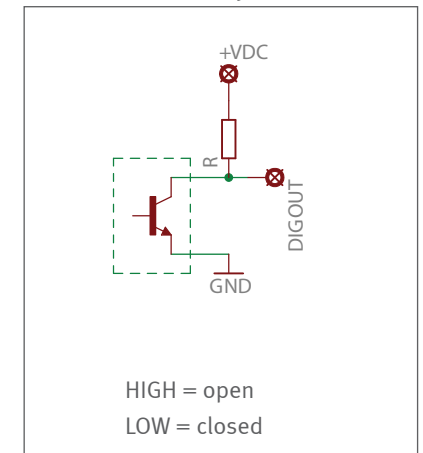

# TTT-300

Bedienungsanleitung  
Operation manual  
Notice d'utilisation  
Instrucciones de servicio  
Istruzioni per l'uso

## 7.0 Testing with test stand

The horizontal test stand for torque wrenches (TTT-920) and the additional element for torque screwdrivers (TTT-921) complete the Tool Torque Tester TTT-300 to a full calibration device.

The test stand is designed for a fast calibration of torque tools according to the standard. By inserting and clamping the tool to be calibrated the specifications made by DIN EN ISO 6789 for correct torque introduction are easily respected.

The test is suitable for manual testing of manually operated, indicating and clicking torque wrenches and torque screwdrivers.

Maximum arm length of torque wrenches is 600 mm and the maximum handle diameter 400 mm.

The additional element TTT-921 enables testing of torque screwdrivers.

Maximum length of torque screwdriver: 250 mm and maximum Handle diameter: 30 mm.

Test stand for calibration



ToolTorqueTester TTT-300 inserted in a test stand with additional element for torque screwdrivers

# TTT-300

Bedienungsanleitung  
 Operation manual  
 Notice d'utilisation  
 Instrucciones de servicio  
 Istruzioni per l'uso

## 8.0 Dimensions and CAD files

You will find dimensional drawings and 3D-CAD files in the [Download-Area](#) on our website.

Product information regarding our [Tool Torque Tester TTT](#) are available on [www.alluris.de](http://www.alluris.de).

For more comprehensive advise regarding specific applications we are happy to help you. Please do not hesitate to contact us.

### Maßzeichnungen im Web

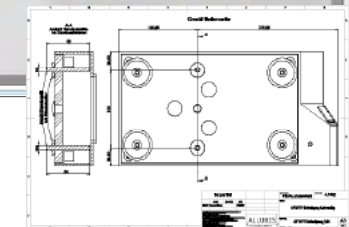
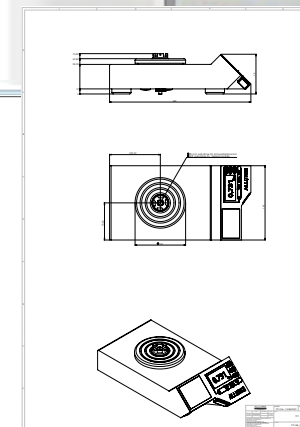
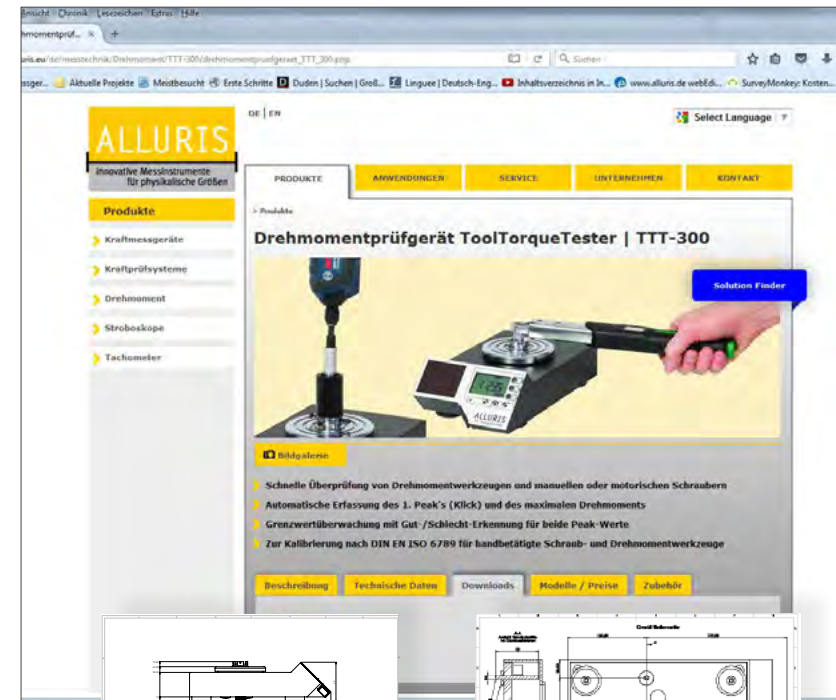

(Click for Download)

# TTT-300

## 9.0 Specifications

Bedienungsanleitung  
 Operation manual  
 Notice d'utilisation  
 Instrucciones de servicio  
 Istruzioni per l'uso

	TTT-300B2	TTT-300B5	TTT-300C1	TTT-300C2	TTT-300C5
Measuring range [Nm]	0,2-2	0,5-5	1-10	2,5-25	5-50
Resolution of display [Nm]	0,002	0,005	0,01	0,025	0,05
Measuring principle	bidirectional force sensor with strain gauge and high-speed $\mu$ -Processor				
Measuring frequency (internal)	up to 3,6 kHz				
Display refresh rate	1 - 10 Hz				
Peak capturing	app. 1 kHz				
Accuracy (f.s. $\pm 1$ digit)	$\pm 0,5$ % (Class 1 DAkkS-DKD-R 3-8)				
Temperature offset (Tk relative) per K	$\pm 0,02$ %				
O-point offset (To absolute) per K	$\pm 0,02$ %				
Tracking (To suppressed)	Auto-Tara (automatic compensation)				
Overload output	●				
Max. overload	$\pm 20$ Nm	$\pm 20$ Nm	$\pm 20$ Nm	$\pm 70$ Nm	$\pm 70$ Nm
USB-interface, max. app. 1kHz	<b>2.0</b>				
Hirose	●				
Detection Peak Click and Peak 2	●				
Memory function	●				
Statistics function	MAX / MIN AVG / DEV				
Limit function	●				
Operating temperature range	0° ... 40° (max. 85 %RH)				
Storage temperature	-10° ... 60° (dry conditions)				
Protection	IP 42 (against dripping water for up to 15° tilt device)				
Supply	Solar cell and internal HighCap-buffer				
Weight	app. 5.000 g				
Dimensions (L x W x H)	280 x 147 x 79 mm				

The instruments are - with the exception of consumable and wearing parts - maintenance free.

Torque gauges should regularly be checked and calibrated, at least once a year, depending on the area of application and frequency of use. Our calibration service includes a technical review of the device, calibration and, if necessary, the adjustment of the measuring range.

# TTT-300

Bedienungsanleitung  
Operation manual  
Notice d'utilisation  
Instrucciones de servicio  
Istruzioni per l'uso

## 10.0 Service

### 10.1. Extended 5-year warranty

We extend the warranty to 5 years from the date of delivery, provided the equipment is registered with us immediately after purchasing and the maintenance and calibration intervals are observed. Excluded are wearing parts and consumables, as well as damage caused by improper use of the device. Otherwise, the warranty shall apply as agreed in our terms and conditions.

### 10.2. Product registration

To enjoy the extended warranty and to be automatically informed about the latest updates or product changes, we recommend to register your Tool Torque Tester TTT [online](#).

### 10.3. Calibration certificates

Torque Tester can be calibrated in our certified calibration laboratory working in accordance with DIN 9001.

Calibration can be performed according to the following standards and directives:

- DAKKS-DKD-R 3-8

Traceability to the national standards of PTB/DKD is guaranteed and will be shown in the calibration certificates.





## 11.0 Frequently asked questions (FAQ)

<p>The depicted peak-value is higher than the maximum value!</p>	<p>The maximum value equals the average value of the last taken single values, whereas the amount of single values depends on the set display update time. The peak value, in contrast, is the absolute highest value measured.</p>
<p>Does the instrument work also after a being stored in the dark for a longer period?</p>	<p>Yes. Even after a self discharging of the internal energy storage the instrument can be used immediately. A back-up battery guarantees the basic function of the device (see p. 8, chapter 3.2 „Energy Harvesting“).</p>
<p>USB communication is disturbed!</p>	<p>Is the right device driver installed? Instruments CTT series must be turned on only after connecting via USB, else they can not be detected. Alternatively, press any button on the device.</p>
<p>The display shows “OvErL” !</p>	<p>Remove the excessive load immediately and check the instrument. If the indicated measuring values are obviously untrue the load cell has to be changed by the manufacturer.</p> <p><b>Important note: After overloading the device the calibration certificate becomes invalid.</b></p>
<p>The instrument turns off automatically!</p>	<p>The auto-off function turns off the instrument, if no button has been pressed for more than five minutes. This period of time can be changed and set between 1 und 90 minutes (see p. 26, chapter 5.2.5 „Auto-Off function (instrument off) (P15)“).</p>



# TTT-300

Konformitätserklärung

Declaration of  
Conformity

Déclaration de  
Conformité

Declaración de  
conformidad

Dichiarazione di  
conformità

## A. Appendix

### A.1 Calibration confirmation acc. DIN EN 10204 2.1

We hereby certify that the equipment has been tested in the production process in accordance with the requirements of DIN EN 9001: 2008. The tester fulfills all values and accuracy described in the technical data.

The instruments and sets of weights used to determine the accuracy are traceable to the globally accepted (ILAC) standards of the Physikalisch-Technische Bundesanstalt (PTB, Braunschweig) and DAkkS ([see p. 40, chapter 10.3 „Calibration certificates“](#)).

## TTT-300

## A.2 Declaration of conformity

## Konformitätserklärung

Declaration of  
ConformityDéclaration de  
ConformitéDeclaración de  
conformidadDichiarazione di  
conformità

We hereby confirm that the below designated product is designed and manufactured in accordance to the general safety and health requirements of EC-Directive 2004/108/EG (EMC-electromagnetic compatibility), 2011/65/EG (RoHS) und der Richtlinie ST/SG/AC.10/11/Rev.5 Section 38.3/Amend.2 (Transport of Dangerous Goods). With any non-authorized changes of the device or application this declaration becomes void.

Manufacturer:	Alluris GmbH & Co. KG Basler Strasse 65 DE 79100 Freiburg, Germany	
Type Number:	TTT-300xx (see type label)	
Description:	Digital Torque Meter (Tool Torque Tester)	
Serial number:	see type label	
Applicable standards:	EN 55022 (RF Emission)	Class B
	EN 61000-4-2 (ESD)	Criteria A
	EN 61000-4-3 (RF Field)	Criteria A
	EN 61000-4-4 (Burst)	Criteria A
	EN 61000-4-8 (Magn. Field)	Criteria A

The compliance to the requirements of all applicable EU directives is confirmed by the CE-marking of the product.

In accordance with WEEE Directive 2012/19/EU this device is categorized as “Monitoring and Control Instrument” and should not be disposed as unsorted municipal waste. You may return it to Alluris for recycling (WEEE Reg.No. DE 49318045). For more information please contact our website [www.alluris.de](http://www.alluris.de).

Alluris GmbH & Co. KG  
Freiburg (DE), 1 June 2016



(Klaus Hartkopf - CEO)

