

Bedienungsanleitung
Operation manual
Notice d'utilisation
Instrucciones de servicio
Istruzioni per l'uso

Deutsche Version
English Version
Version française
Versión española
Versione italiana

CTT-200
CTT-300

Operation Manual

Cap Torque Tester

CTT-200
CTT-300



CTT-200

CTT-300

Bedienungsanleitung
Operation manual
Notice d'utilisation
Instrucciones de servicio
Istruzioni per l'uso

Content

1.0	General remarks	3			
1.1.	Used Symbols	3			
2.0	Safety instructions	4			
2.1.	Proper use	4			
2.2.	Environmental conditions for safe operation	4			
2.3.	Hazard Warnings	5			
2.4.	Disclaimer	5			
3.0	Before starting operation	6			
3.1.	Scope of delivery	6			
3.2.	Energy Harvesting	7			
3.3.	Overview	8			
3.4.	Set-up functions	8			
3.5.	Control panel	9			
4.0	Starting Operation	10			
4.1.	Installation and connection	10			
4.2.	Inserting the test object	11			
4.3.	Turning the instrument ON/OFF	12			
4.3.1.	Changing measuring units	12			
4.4.	Selecting the measuring mode	13			
4.4.1.	Standard (Default)	13			
4.4.2.	Measuring mode: Peak CCW	14			
4.4.3.	Measuring mode: Peak Actual-Value	14			
4.4.4.	Measuring mode: Peak CW	15			
4.5.	Start/Stop measurements	16			
4.6.	Taring	17			
4.7.	Reset the drag indicator	17			
4.8.	View readings	18			
4.8.1.	View readings in standard mode	18			
4.8.2.	View results in peak modes with CTT-200	18			
4.8.3.	View first/second peak values with CTT-300	19			
4.9.	Clear data	20			
5.0	Setting Measurement Parameters	21			
5.1.	Parameter Menu	22			
5.2.	General settings (P1)	22			
5.2.1.	Change measuring unit (P11)	23			
5.2.2.	Change prefix for CCW mode and CW mode (P12)	24			
5.2.3.	Display-refresh rate (P13)	24			
5.2.4.	Auto-Stop - automatic measuring stop (P14)	24			
5.2.5.	Auto-Off function (instrument off) (P15)	24			
5.2.6.	Auto-Tara - automatic taring (P16)	25			
5.2.7.	Buzzer - activating the signal tone (P17)	25			
5.3.	Reset to factory defaults (PO)	25			
5.4.	Memory and Statistics function (P2)	26			
5.4.1.	General explanation of the memory function	27			
5.4.2.	Activating the memory and statistics function	27			
5.4.3.	Storage of single values	27			
5.4.4.	View statistics	28			
5.4.5.	Clear memory	28			
5.5.	Monitoring limit values (P3 bis P6)	28			
5.5.1.	Working with the limit value (threshold) function	29			
5.5.2.	Setting limit values	29			
5.5.3.	Delete limit values	30			
5.6.	Threshold for start of 2nd peak measurement (P7)	31			
6.0	Data transfer	32			
6.1.	Data transfer via USB	32			
6.1.1.	Software FMI_Analyze	32			
6.1.2.	Software COM-Bridge	32			
6.2.	Hirose socket	33			
6.2.1.	Foot switch for data transfer	33			
6.2.2.	Data cable for digital I/Os	34			
7.0	Dimensions and CAD files	35			
8.0	Specifications	36			
9.0	Service	37			
9.1.	Extended 5-year warranty	37			
9.2.	Product registration	37			
9.3.	Calibration certificates	37			
10.0	Frequently asked questions (FAQ)	38			
A.	Appendix	39			
A.1	Notes	39			
A.2	Calibration confirmation acc. DIN EN 10204 2.1	39			
A.3	Declaration of conformity	40			

CTT-200 CTT-300

Bedienungsanleitung
Operation manual
Notice d'utilisation
Instrucciones de servicio
Istruzioni per l'uso

Thank you for choosing one of our high quality instruments. Please read the entire operation manual thoroughly before using this instrument for the first time. The information contained herein will help you to achieve accurate and reproducible results and to avoid misuse or damages.

1.0 General remarks

1.1 Used Symbols

Note

Helpful information that facilitates the operation of the instrument.



Attention

Non-observance of the associated information may result in damage of the instrument.



Attention

Non-observance of the associated information may result in injury.



CE

The unit conforms to the applicable European directives.



WEEE Directive

The device is subject to the WEEE Directive.



Calibration certificate

The instrument was tested in certified calibration laboratory.



CTT-200 CTT-300

Bedienungsanleitung
Operation manual
Notice d'utilisation
Instrucciones de servicio
Istruzioni per l'uso

2.0 Safety instructions

Instruct the operators according to the instructions in this manual. Deliver all information about the field of application and the possible hazards during operation. Keep this manual for future use at hand for the operation personnel.

2.1. Proper use

The Cap Torque Tester CTT is used for torque testing to determine the forces needed to open and close screw caps or lids.

The torque sensor may be damaged due to overload! Observe the maximum measuring range of your device! The maximum measuring range is indicated on the typeplate on the underside.

The portable Cap Torque Tester CTT is designed for desk top use. If you want to fix the position of the torque tester and to prevent it from slipping, you can fix it on the bench. Use exclusively the provided threaded holes on the underside of the instrument.

2.2. Environmental conditions for safe operation

Observe the permissible environmental conditions for the instrument. It is designed for indoor use up to an altitude of 2,000 m above sea level. The instrument is equipped with an automatic temperature compensation from 0 ° ... 40 ° C (max. 85% RH). Use the device only under this conditions.



CTT-200 CTT-300

Bedienungsanleitung
Operation manual
Notice d'utilisation
Instrucciones de servicio
Istruzioni per l'uso

2.3. Hazard Warnings

- If the instrument is not operated according to this manual, the protection provided is no longer guaranteed.
- Do not measure objects or products filled with liquids. While the instrument is protected against dripping water, permanently leaking fluids could damage the instrument or distort measurement results.
- The instrument is intended for use by trained personnel. Operation and maintenance may only be performed by trained personnel. Repairs may be carried out only by Alluris or authorized servicing dealers.



2.4. Disclaimer

Alluris disclaims any damages or warranty claims when

- the instrument is used for other purposes than those specified in this operation manual;
- the product is changed in any way - other than those alterations described in this manual;
- the product is not repaired by Alluris or authorized servicing dealers;
- the product will be used despite obvious safety faults;
- the product is subjected to mechanical impacts or is dropped;
- accessories are used that have not been released by Alluris.



CTT-200

CTT-300

Bedienungsanleitung
 Operation manual
 Notice d'utilisation
 Instrucciones de servicio
 Istruzioni per l'uso

3.0 Before starting operation

Please check the content before using the equipment. Make sure that the packaging and the device have no transport damage. If you suspect any damage from transport, please notify immediately our service.

If despite our careful final inspection any items are missing, please inform your dealer or our customer service via service@alluris.de.

You find all items listed in table 3.1, if you want to order a replacement at a later date.

Additional accessories can be found on www.alluris.de.

3.1. Scope of delivery

<ul style="list-style-type: none"> ● Standard scope of delivery (part no.) ○ Optional accessories (not included) 	CTT-200	CTT-300
Base unit (Typeplate with serial number and measuring range on the underside)	●	●
Quickstart manual	●	●
Standard centering plate (CTT-905)	●	●
Location rails for chuck pins (CTT-906)	●	●
Chuck pins (CTT-901)	●	●
Universal VAC power supply and charger with EC-, UK- and US wall plug connector and USB-cable (FMI-946)	○	○
USB interface cable (FMI-931USB)	●	●
Cable for digital I/Os (FMI-934SO)	○	○
FMI_Analyze (FMI-975) software license	○	○
COM-Bridge (FMI-977) software license	○	○
Calibration certificate with data (TMI-800 or TMI-810)	○	○
Protection case (TMI-915)	○	○

CTT-200 CTT-300

Bedienungsanleitung
Operation manual
Notice d'utilisation
Instrucciones de servicio
Istruzioni per l'uso

3.2. Energy Harvesting

Cap Torque Tester CTT utilize, also when turned off, the ambient light at the work place as energy source. The energy is stored in the instrument, to ensure that tests can be made even if the solar cell is covered for a short while.

After keeping the instrument for more than 2 month in the dark, you should expose it to light for at least 8 hours in the regular working environment (> 250 Lux) before use. Or you may use the USB-cable to charge the instrument quickly. A buffer battery maintains in any case the basic functions of the instrument.

Control panel of Cap Torque Tester CTT with solar cell

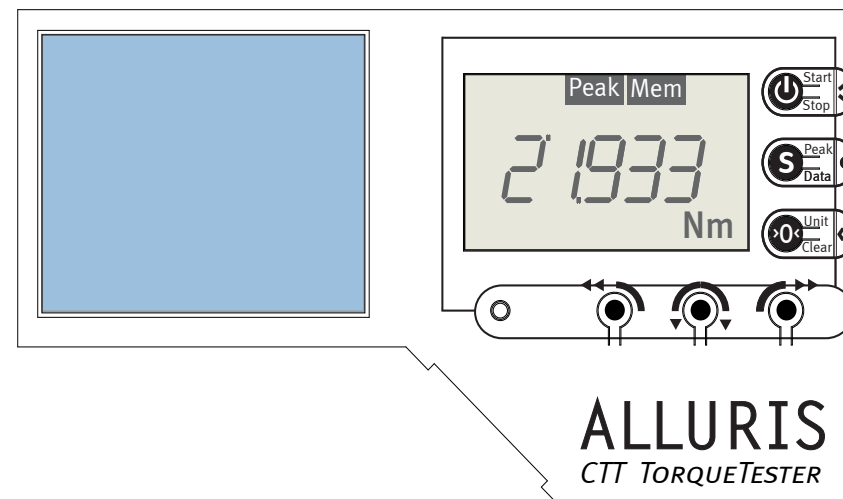

3.3. Overview



USB 2.0 Mini-B-socket

Function	Accessory part	Part number
Data analysis on PC	Software FMI_Analyze	FMI-975
Data transfer (e. g. to CAQ Software)	Software FMI_Analyze	FMI-977
Power supply	Universal-charger with USB cabel	FMI-946
Data transfer to PC	USB data cable	FMI-931USB

Hirose-socket

Funktion	Zubehör	Artikelnummer
Trigger signals	Foot switch	FMT-936
Transfer of digital I/Os	Cable, 15-pin	FMI-934SO

CTT-200 CTT-300

Bedienungsanleitung
Operation manual
Notice d'utilisation
Instrucciones de servicio
Istruzioni per l'uso

3.4. Set-up functions

1	Exchangeable centering plate (CTT-905)
2	Location rails for chuck pins (CTT-906) (L = approx. 180 mm; 4 x six positions)
3	Chuck pins (CTT-905) (H = 25 mm, Ø = 35 mm) More accessories for individual tasks see www.alluris.de
4	Hand wheel for clamping the test objects
5	Display
6	Solar cell Collects energy even if the instrument is switched off.
7	USB 2.0 Mini socket for data transfer and also for charging the buffer battery after long storage in the dark
8	15-pin Hirose socket (for digital I/Os, service, calibration ecc.)
9	Threaded holes (M6) on the underside with threaded bolt and knurled nut for table mounting



Underside

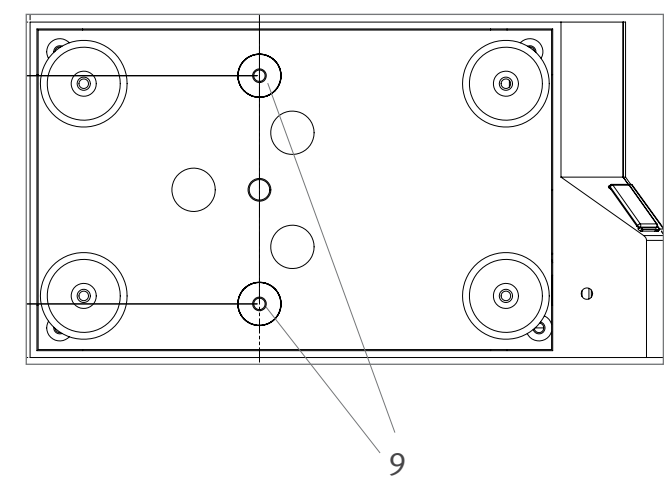

CTT-200 CTT-300

Bedienungsanleitung
Operation manual
Notice d'utilisation
Instrucciones de servicio
Istruzioni per l'uso

3.5. Control panel

1	LCD-Display 4-digit display of measured values and measurement modes
2	I-key <ul style="list-style-type: none"> On/ Off (press 2 seconds) Start/ Stop measurement select next item in menus
3	S-key <ul style="list-style-type: none"> store data show measuring results enter / exit parameter menu (press 2 seconds) apply changes in the parameter menu
4	O-key <ul style="list-style-type: none"> delete individual values delete all values and reset to "idle" (press 2 seconds) tare manually in parameter menu: enter submenus change measurement unit
5	LED signal limit monitoring active with plugged USB-cable, switches between red (= bad) and green (= good)
6	Mode-button for measuring mode - Peak CCW toggles between the measurement modes "Standard" and "Peak CCW" (counterclockwise). "Peak CCW" measures the torque peak in the counterclockwise direction (with drag pointer function).
7	Mode-button for measuring mode - Peak-Actual-Value toggels between the measurement modes "Standard" and "Peak Actual-Value" (actual measured value). "Peak Actual-Value" measures the torque peak in both directions (with drag pointer function).
8	Mode-button for measuring mode - Peak CW toggles between the measurement modes "Standard" and "Peak CW" (clockwise). "Peak CW" measures the torque peak in the clockwise direction (with drag pointer function).

Control panel

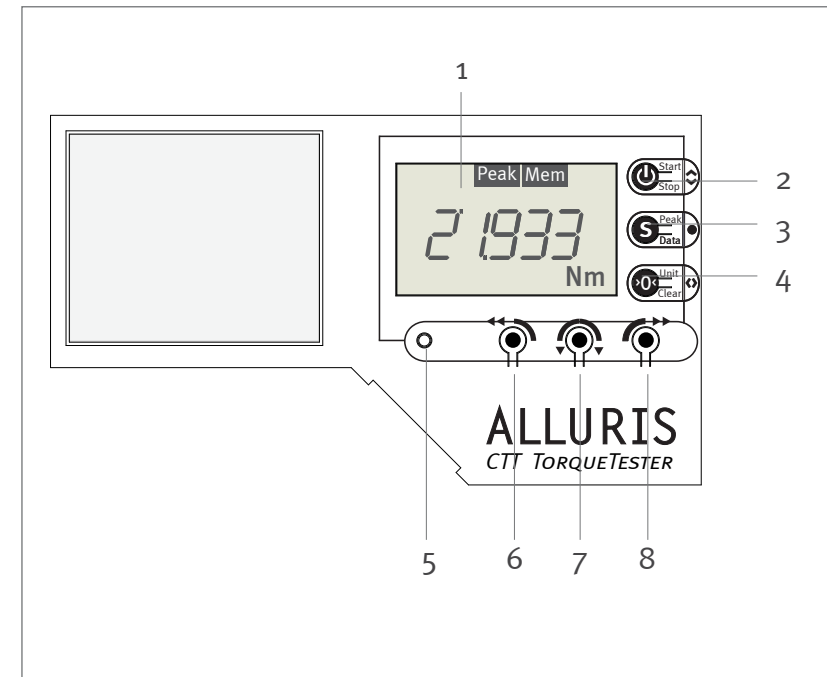

CTT-200

CTT-300

Bedienungsanleitung
Operation manual
Notice d'utilisation
Instrucciones de servicio
Istruzioni per l'uso

4.0 Starting Operation

4.1 Installation and connection

Remove the transport protection and place the instrument on a flat stable surface. The surface should be clean and free of grease.

For fixed positioning the device can be screwed as an additional safeguard against slipping with the bench (thickness up to 30 mm). For this purpose two holes and threaded bolts with knurled nuts are located on the bottom side.

The instrument requires no external power supply as a built-in solar cell supplies the necessary power.

The audible signal (buzzer) and LED signal only work if the device is connected to an external power supply. An universal power supply USB (FMI-946) is needed.

For data transfer to PC, first install the software „FMI_Analyze“ (FMI-975) on the PC and then connect the USB data cable (FMI-931USB) to the USB socket.

If you want to trigger the data transfer via a foot switch, install the [software COM-Bridge](#) (FMI-977) and connect the [foot switch for data transfer](#) (FMT-936) to the Hirose-socket.

For the digital transmission of status limit/overload and trigger signals etc. you need the appropriate [data cable for digital I/Os](#) (FMI-934SO).



CTT-200 CTT-300

Bedienungsanleitung
Operation manual
Notice d'utilisation
Instrucciones de servicio
Istruzioni per l'uso

4.2. Inserting the test object

- Open the centering unit by turning the handwheel on the right side of the instrument.



- Insert the four chuck pins, depending on the size and shape of the test object, into the holes of the two rails on the centering table.



Additional clamping devices for the centering table for your specific application can be found at www.alluris.de.

- Place the test object between the chuck pins as shown in the picture. The rotation axis of the test object must be located in the center of the measuring plate.



- Pay special attention to the proper alignment of non rotationally symmetric test objects. The test axis of rotation must coincide with the center mark on the centering plate. If the axes, as shown in the figure on the right, does not match, you'll receive incorrect results.



- Now turn the handwheel clockwise; in this way the measuring sample is clamped by the chuck pins. Before starting the measurement please make sure that the test object is gripped firmly, but not as tight that the object to be measured - e.g. glass - could be damaged.



CTT-200 CTT-300

Bedienungsanleitung
Operation manual
Notice d'utilisation
Instrucciones de servicio
Istruzioni per l'uso

4.3. Turning the instrument ON/OFF

Turn on the instrument with the I-key. During a short self test three information displays appear consecutively in quick succession on the display. They show the device type, the date the next calibration is due and the nominal measuring range. Once the routine is completed the device is ready for use (idle).

At the start of each measurement an automatic tare is performed (see p. 25, chapter 5.2.6 „Automatic Taring – Auto-Tara“).

Pressing the I-key for two seconds you turn the instrument off.

After 5 minutes of inactivity the **auto-off function** turns off the instrument automatically, when no external power source is connected. You can adjust this period of time in parameter menu P15 (see p. 25, chapter 5.2.5 „Auto-Off function“).

4.3.1. Changing measuring units

A fast way to change the measuring unit is pressing the O-key when the instrument is idle. You can select either Nm (Default) or cNm as measuring unit.

Alternatively you may change the measuring unit via the parameter menu P11 (see p. 24, chapter 5.2.2 „Change prefix for CCW mode and CW mode“).

Self test after turning on the instrument

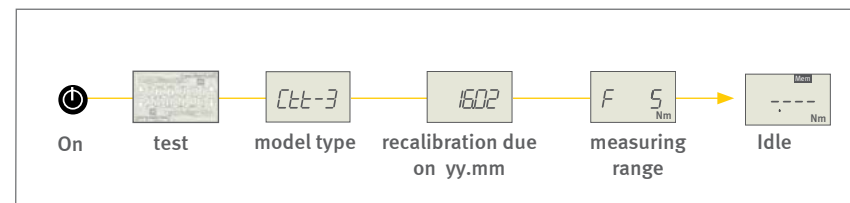

Changing the measuring unit

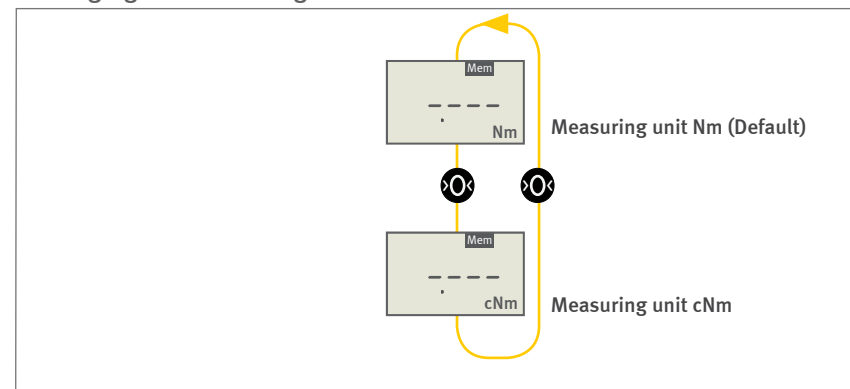

CTT-200

CTT-300

Bedienungsanleitung
 Operation manual
 Notice d'utilisation
 Instrucciones de servicio
 Istruzioni per l'uso

4.4. Selecting the measuring mode

When the instrument is ready for use (idle) you can activate/deactivate different measuring modes with the directional keys:

- Standard (Default)
- Peak CCW (Counterclockwise)
- Peak Actual-Value
- Peak CW (Clockwise)

With the selection of a particular measurement mode, you determine which of the measured values should be shown (peak values or the currently measured value) and in which direction and with what frequency the instrument measures.

With instruments of CTT-300 series you can automatically detect a second peak, e. g. for the testing of tamper evident closures.

4.4.1. Standard (Default)

If you have not selected any of the three peak modes, the instrument operates in the standard mode and always shows - when measuring - the current measured value. By default counter-clockwise measured torque values are shown as negative. You may change this setting ([see p. 24, chapter 5.2.2 „Change prefix for CCW mode and CW mode“](#)).

In this measurement mode the device measures with default frequency.

Directional keys for measuring mode selection

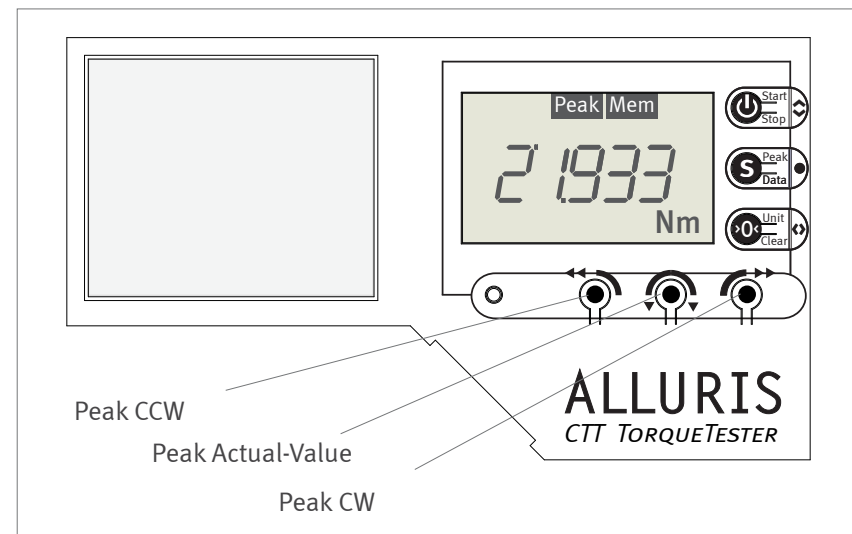

CTT-200 CTT-300

Bedienungsanleitung
Operation manual
Notice d'utilisation
Instrucciones de servicio
Istruzioni per l'uso

4.4.2. Measuring mode: Peak CCW

In this measurement mode, the peak torque is measured and displayed while turning the test object counterclockwise (CCW). By default counterclockwise measured torque values are shown as negative. You may change this setting (see p. 24, chapter 5.2.2 „Change prefix for CCW mode and CW mode“).

The counterclockwise direction is in screw caps usually opening. If you turn the test object in the other direction - clockwise - , the values are not displayed.

Instruments CTT-300 series can capture two consecutive peaks, e. g. for testing tamper evident closures (see p. 20, chapter 4.8.3 „View first/second peak values with CTT-300“).

The display corresponds to a drag indicator, which is further advanced only at increasing values. If the measurement values are decreasing, the display remains unchanged. You can reset the drag indicator during the measurement by pressing the 0-key (see p. 17, chapter 4.7 „Reset the drag indicator“).

The following symbols on the display indicate that the measurement mode is active: the direction indicator moves counterclockwise and on the top edge of the screen appears a peak symbol.

The instrument measures with increased frequency (high-speed measurement with about 1 kHz).

4.4.3. Measuring mode: Peak Actual-Value

In this measurement mode, the current measured value (actual value) is displayed namely in both directions of rotation. By default counterclockwise measured torque values are shown as negative. You may change this setting (see p. 24, chapter 5.2.2 „Change prefix for CCW mode and CW mode“).

A flashing peak symbol at the edge of the display indicates that this measurement mode is active.

The instrument measures with increased frequency (high-speed measurement with about 1 kHz).



Directional key
Peak CCW

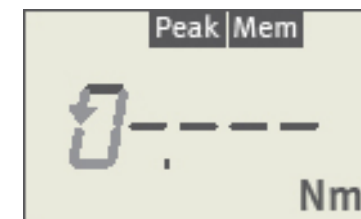

Instrument is ready for use in measuring mode Peak CCW.

On the left the indicator for the counterclockwise direction.



Directional key
Peak Actual-Value

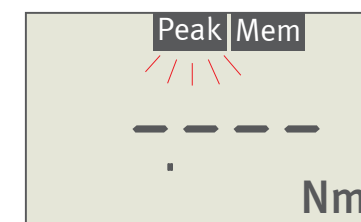

Instrument is ready for use in measuring mode Peak Actual-Value

CTT-200 CTT-300

Bedienungsanleitung
Operation manual
Notice d'utilisation
Instrucciones de servicio
Istruzioni per l'uso

4.4.4. Measuring mode: Peak CW

In this measurement mode, the peak torque is measured and displayed while turning the test object clockwise (cw). If you turn the test object in the other direction - counterclockwise - , the values are not displayed.

Instruments CTT-300 series can capture two consecutive peaks, z. B. for testing tamper evident closures (see p. 20, chapter 4.8.3 „View first/second peak values with CTT-300“).

The display corresponds to a drag indicator, which is further advanced only at increasing values. If the measurement values are decreasing, the display remains unchanged. You can reset the drag indicator during the measurement by pressing the O-key (see p. 17, chapter 4.7 „Reset the drag indicator“).

The following symbols on the display indicate that the measurement mode is active: the direction indicator moves clockwise and on the top edge of the screen appears a peak symbol.

The instrument measures with increased frequency (high-speed measurement with about 1 kHz).



Directional key
Peak CW

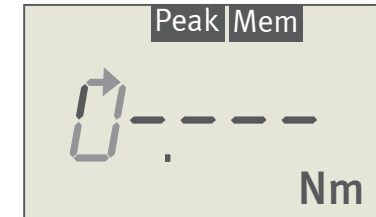

Instrument is ready for use in measuring mode Peak CW.

On the left the symbol for the clockwise direction.

CTT-200 CTT-300

Bedienungsanleitung
Operation manual
Notice d'utilisation
Instrucciones de servicio
Istruzioni per l'uso

4.5. Start/Stop measurements

Insert the test object and verify that it is firmly gripped (see p. 11, chapter 4.2 „Inserting the test object“).

Start:

Start the measurement by pressing the I-key. The display now shows „0.000“ (or „00.00“ for devices with a measuring range 10 Nm). The unit symbol in the display starts flashing.

Measuring:

The display shows the current measured value or the previously reached peak value is constantly displayed (see p. 13, chapter 4.4 „Selecting the measuring mode“). During the measurement, the unit flashes on the display.

If the instrument is connected to an external power source, a permanent tone signals when the current measured value / peak value is within pre-set limits. Otherwise you will hear an intermittent tone (see p. 25, chapter 5.2.7 „Activating the signal tone Buzzer“).

Stop:

Pressing the I-Key again stops the measuring.

Storing a value during the measurement with the S-key stops the measurement as well.

Using the Auto-Stop-Function (see p. 24, chapter 5.2.4 „Automatic measuring stop – Auto-Stop (P14)“) the measurement is stopped automatically when the measured value remains unvaried within a specified period of time.

After stopping the measurement, the measured value appears on the display. Depending on the selected measurement mode, this is either the last measured value or the respective peak. The unit symbol stops flashing.

CTT-200: Display during measurement

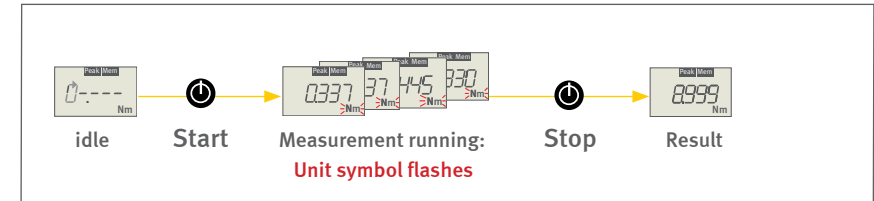

CTT-300: Display during measurement in Peak CW or Peak CCW mode

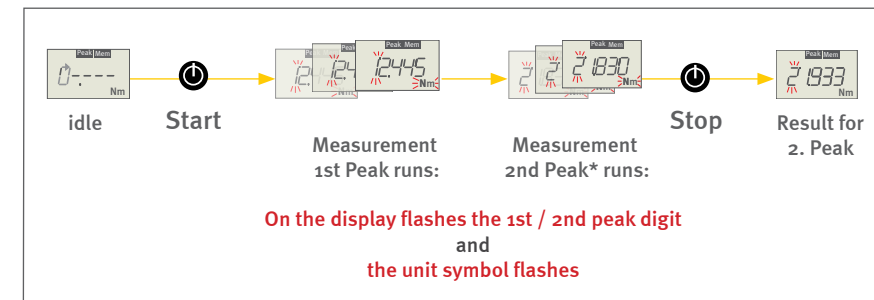

*Provided that a 2nd peak occurs and the threshold for the start of the 2nd peak value has been passed (see p. 31, chapter 5.6. “Threshold for start of 2nd peak measurement”).

CTT-200 CTT-300

Bedienungsanleitung

Operation manual

Notice d'utilisation

Instrucciones de servicio

Istruzioni per l'uso

4.6. Taring

At the start of each measurement an automatic tare (auto-tare function) is carried out to compensate for the weight of the test piece and the occurring tension while applying force. In addition, there is an automatic compensation of the temperature drift.

The auto-tare function can be switched off (see p. 25, chapter 5.2.6 „Automatic Taring – Auto-Tara (P16)“).

Due to the sensitivity of the instrument a value which is not zero may be displayed due to barely perceptible vibrations.

In the measurement modes **Standard** and **Peak Actual-Value** you can tare the instrument during the measurement by pressing the O-key. Instruments of the CTT-300 series reset both peak values simultaneously.

4.7. Reset the drag indicator

When the measurement modes **Peak CCW** or **Peak CW** are set, you may reset the drag pointer function by pressing the O-key during an ongoing measurement. The instrument will not be tared but reset to the actual measured value.

Instruments CTT-300 series reset both peak values at the same time and the measurement of the first peak restarts immediately.



CTT-200

CTT-300

4.8. View readings

4.8.1. View readings in standard mode

In standard mode, the unit displays the current measured value. After stopping the measurement, the display shows the last measured value.

If you have activated the memory function before starting the measurement (see p. 27, chapter 5.4.2 „Activating the memory and statistics function“), you can view statistical values to the readings you have saved (grey area in the graph). The diagram shows the order in which the values are displayed on the screen.

Maximum - Highest Value of all stored values.

Minimum - Lowest Value of all stored values.

Average - arithmetic average of stored values

Deviation - from average

To recall statistical values press the S-key after stopping the measurement. The first result will appear (see chart on the left). Use the S-key to scroll down through the items.

Bedienungsanleitung
Operation manual
Notice d'utilisation
Instrucciones de servicio
Istruzioni per l'uso

Standard mode with memory active:
Screen sequence of stored readings and statistical values

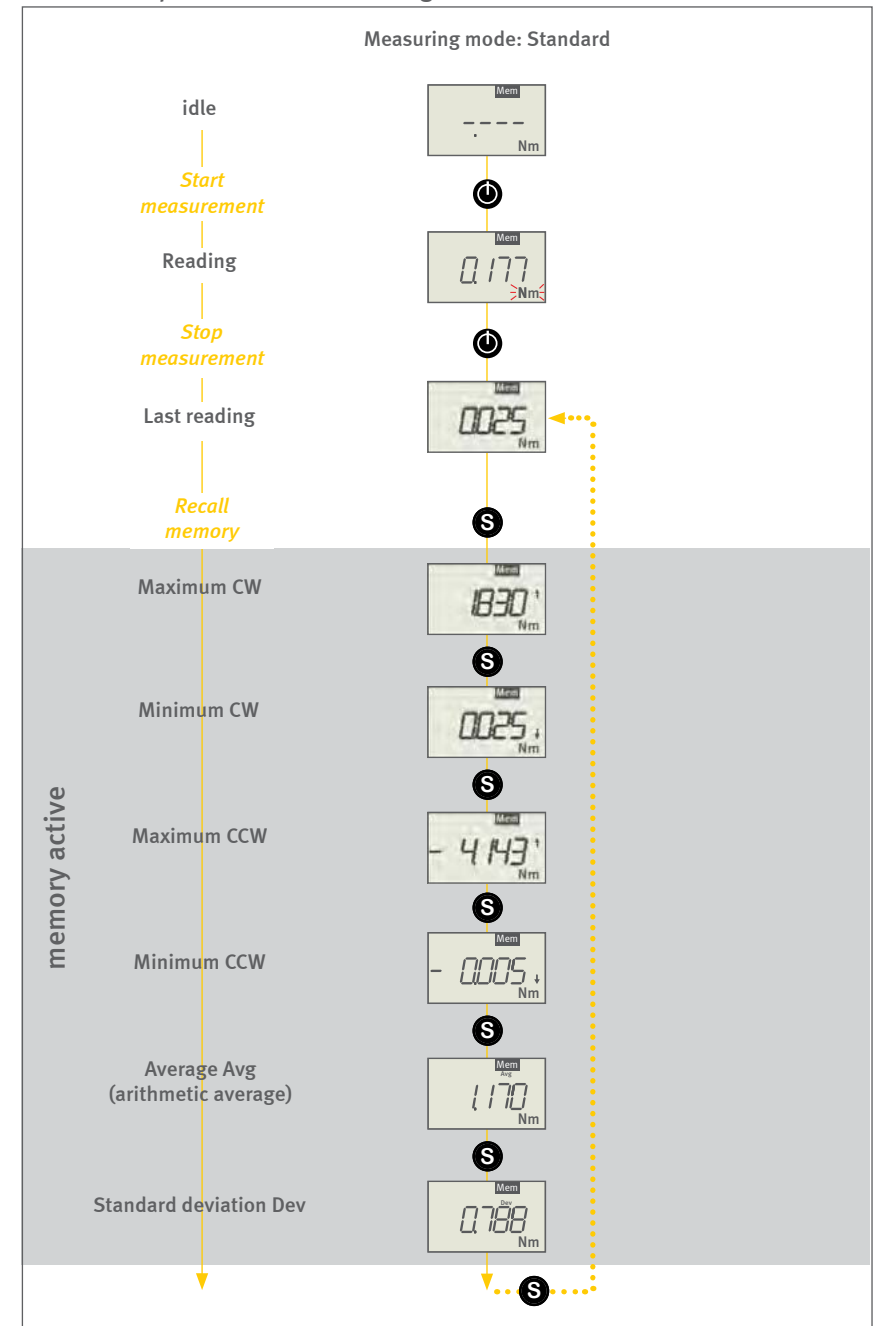

CTT-200 CTT-300

Bedienungsanleitung
Operation manual
Notice d'utilisation
Instrucciones de servicio
Istruzioni per l'uso

4.8.2. View results in peak modes with CTT-200

In the three peak modes, the device displays during and after stopping the measurement the peak counterclockwise (**Peak CCW**) the peak clockwise (**Peak CW**) or in **Peak Actual-Value** mode the current measured value.

The Peak Actual-Value mode detects and stores the peak values in both directions. After the measurement, you can recall the two peak values by pressing the S-key.

With active memory function (see p. 27, chapter 5.4.2 „Activating the memory and statistics function“) statistical values are calculated for all memorized data.

Maximum - Highest Value of all stored values.

Minimum - Lowest Value of all stored values.

Average - arithmetic average of stored values

Deviation - from average

To recall memorized values and statistical values press the S-key after stopping the measurement. The first result will appear (see chart on the left). Use the S-key to scroll down through the items.

The peak symbol on the top edge of the display flashes while displaying the statistical values: maximum, minimum, average and deviation. The symbol remains permanent when peak values are displayed.

Press the I-Key to start a new measurement. With the start of a new measurement the peak values are reset.

Peak modes with CTT-200:
Screen sequence of stored readings and statistical values

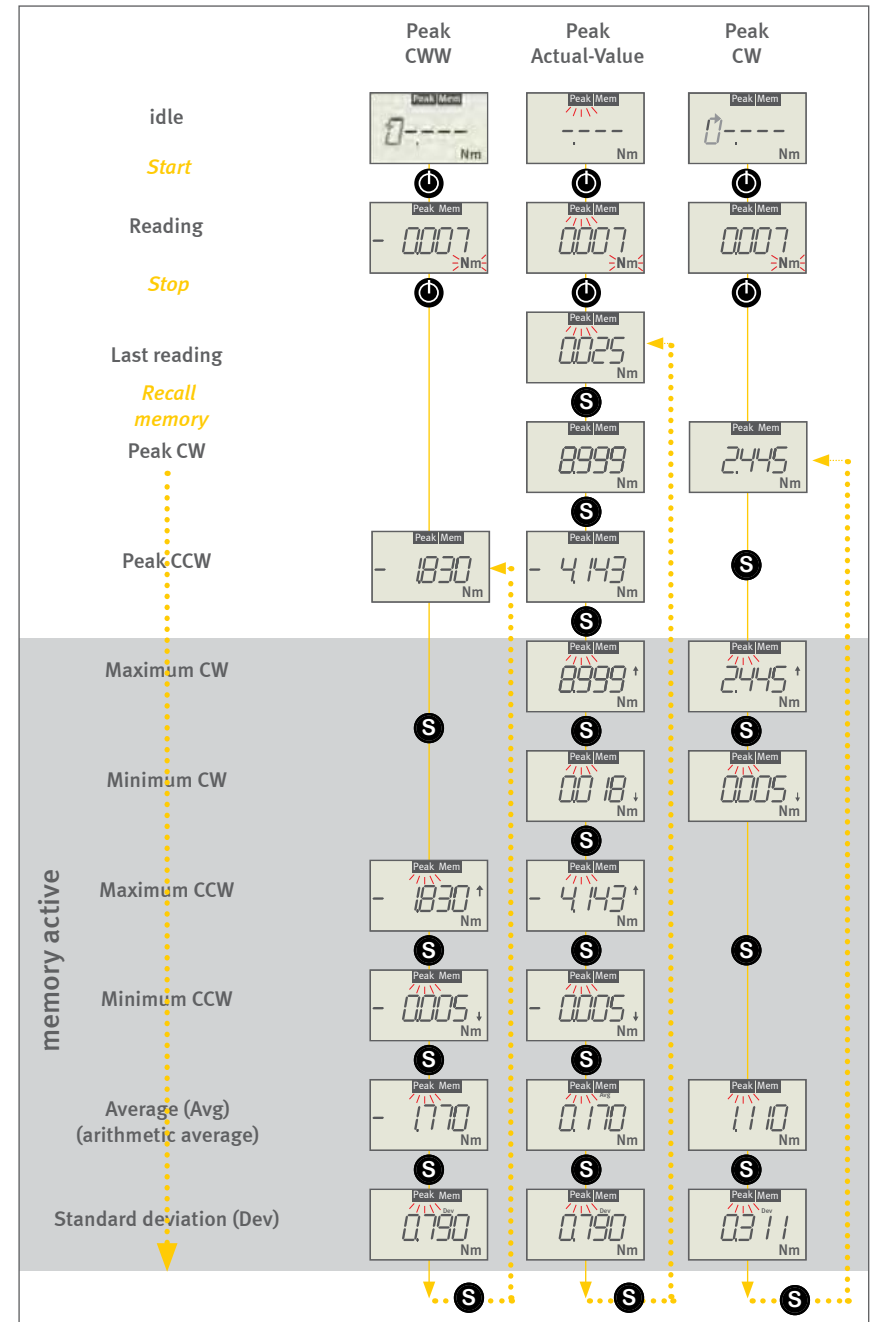

CTT-200

CTT-300

Bedienungsanleitung
 Operation manual
 Notice d'utilisation
 Instrucciones de servicio
 Istruzioni per l'uso

4.8.3. View first/second peak values with CTT-300

The CTT-300 series instruments can detect two consecutive peaks when using the measuring modes **Peak CCW** or **Peak CW**.

After stopping the reading the display indicates the last detected peak.

To recall memorized values and statistical values press the S-key after stopping the measurement. The first result will appear as shown in the chart on the left). Use the S-key to scroll down through the items.

The sequence shows first the four statistical values for the first peak and then for the second peak. After the statistics for the second peak the screen returns to the beginning of the sequence displaying the peak values.

Press the I-Key to start a new measurement. With the start of a new measurement the peak values are reset.

Screen sequence second peak with CTT-300

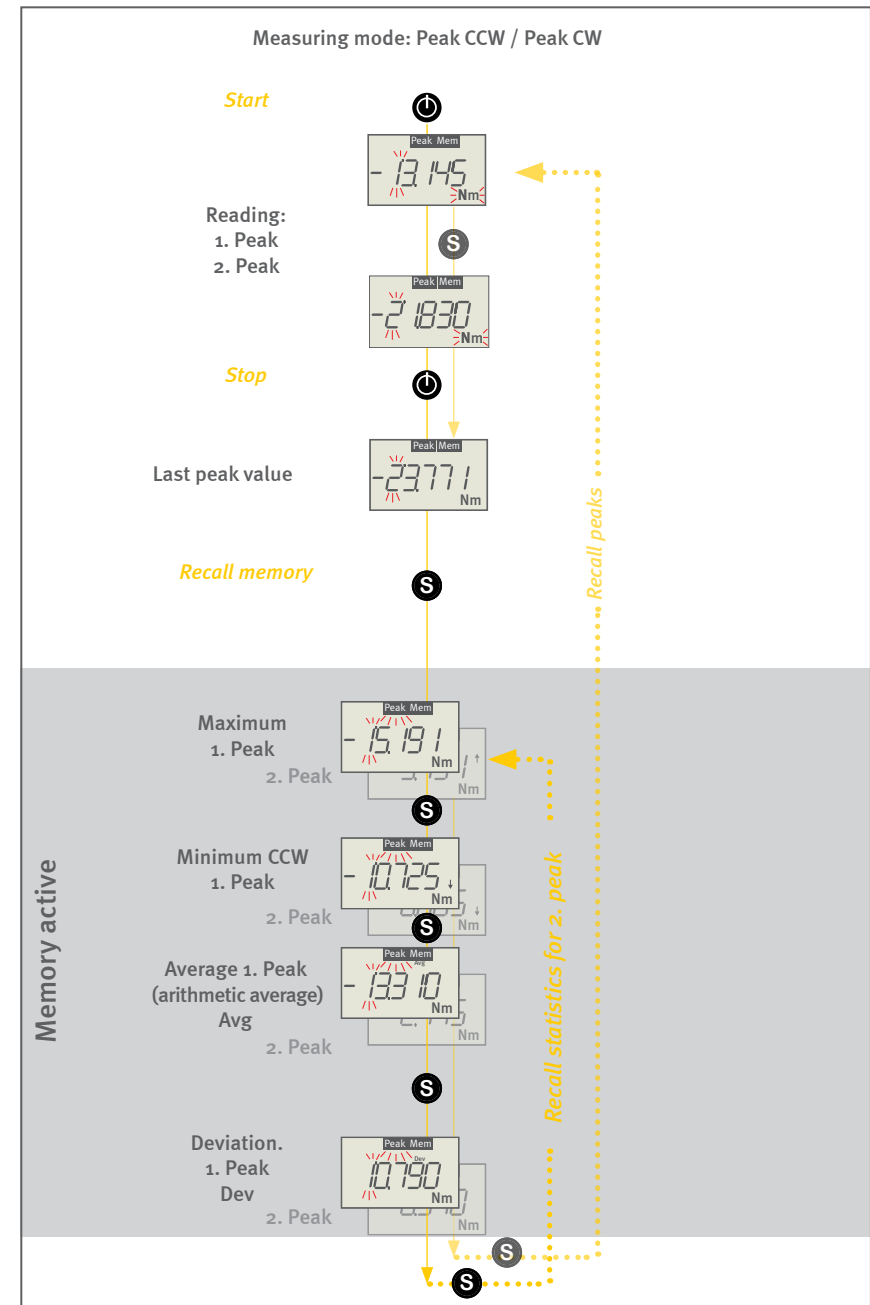

CTT-200 CTT-300

Bedienungsanleitung
Operation manual
Notice d'utilisation
Instrucciones de servicio
Istruzioni per l'uso

4.9. Clear data

You may delete the memory content selectively or completely with the O-key.

Any stored readings in the memory may be deleted individually by pressing the O-key. The display will show "0.00", or „00.00“. With the S-key you can select the next item in the memory.

Statistical values cannot be deleted individually.

Press the O-key for two seconds to delete all stored values (values and statistics) at the same time. The idle-display will appear as soon as the memory is cleared completely.

Deleting values **individually**

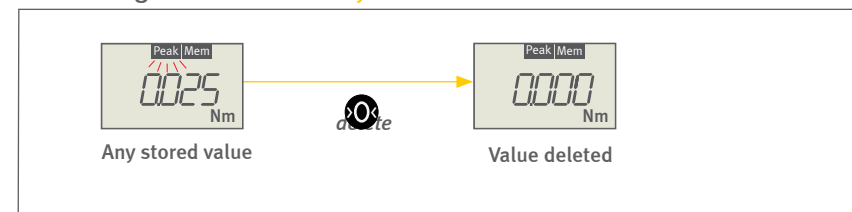

Clear memory **completely**

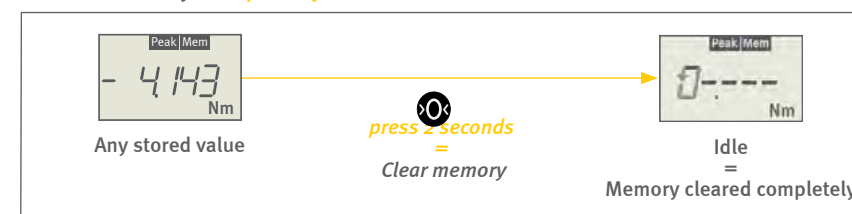

CTT-200

CTT-300

Bedienungsanleitung
Operation manual
Notice d'utilisation
Instrucciones de servicio
Istruzioni per l'uso

5.0 Setting Measurement Parameters

5.1. Parameter Menu

The instrument's basic functions and parameters are configured through the parameter menu.

The instruments offer a memory and statistical function as well as a monitoring function with limit values. These functions can be activated and adjusted via the parameter menu.

When the instrument is ready for use (idle), call with a long press on the S-key the parameter menu. In the same way you revert from any point in the parameter menu to the operation mode.

The parameter menu offers seven submenus as indicated below. With the I-key you can scroll down through the items. Enter a menu with the O-key.

- P1 General Settings
(see p. 23, chapter 5.2 „General settings“)
- P2 Memory and Statistics function
(see p. 27, chapter 5.4 „Memory and Statistics function“)
- P3 Monitoring - Upper limit
(see p. 29, chapter 5.5 „Monitoring limit values“)
- P4 Monitoring - Lower limit
(see p. 29, chapter 5.5 „Monitoring limit values“)
- P5 Upper Limit for 2. Peak (CTT-300)
(see p. 29, chapter 5.5 „Monitoring limit values“)
- P6 Lower Limit for 2. Peak (CTT-300)
(see p. 29, chapter 5.5 „Monitoring limit values“)
- P7 Threshold for Start of 2. Peak-Measuring (ab CTT-300)
(see p. 31, chapter 5.6 „Start of 2. peak measurement“)
- PO Reset to Factory Defaults
(see p. 26, chapter 5.3 „Reset to factory defaults“)

Accessing parameter menu items

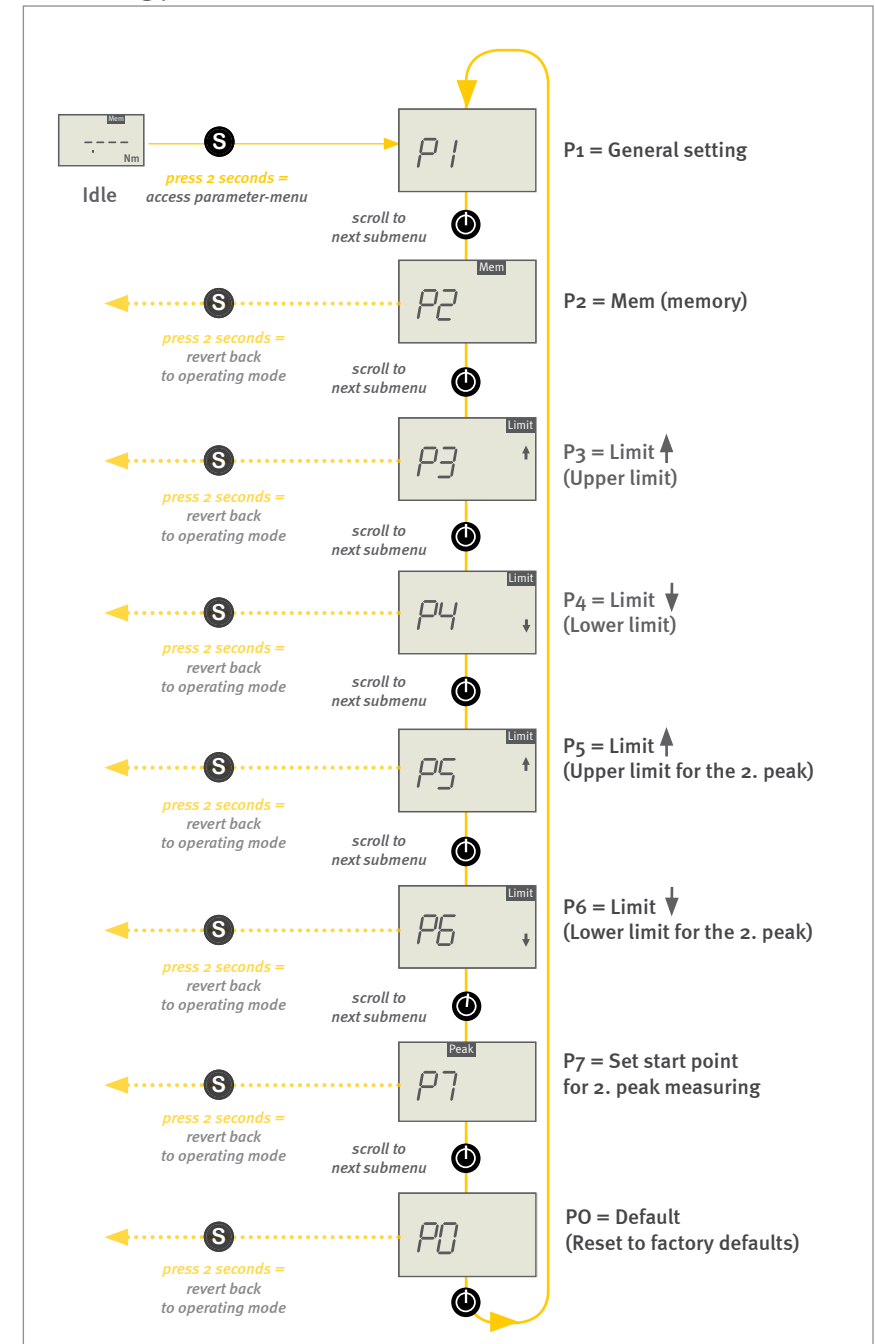

CTT-200 CTT-300

5.2. General settings (P1)

With menu P1 „General settings“ you may adjust the main features and settings of the Cap Torque Tester CTT.

The following submenus are available:

- P11 Change measuring units
- P12 Change +/- prefix
- P13 Display-Refresh-Rate
- P14 Automatic Measuring-Stop - **Auto-Stop**
- P15 **Auto-Off** Function (instrument off)
- P16 Automatic Taring - **Auto-Tara**
- P17 Select/Deselect **Buzzer**

With the O-key you scroll through the submenus offered in menu P1. Enter a menu with the I-key.

In all submenus you may toggle with the I-key between the offered parameter settings. The actual selection flashes.

To select the parameter you may either press the S-key and revert at the same time one step back in the menu hierarchy or press the O-key to select the next submenu.

Press for 2 seconds the S-key to revert back to the operation mode.

Enter submenus in P1

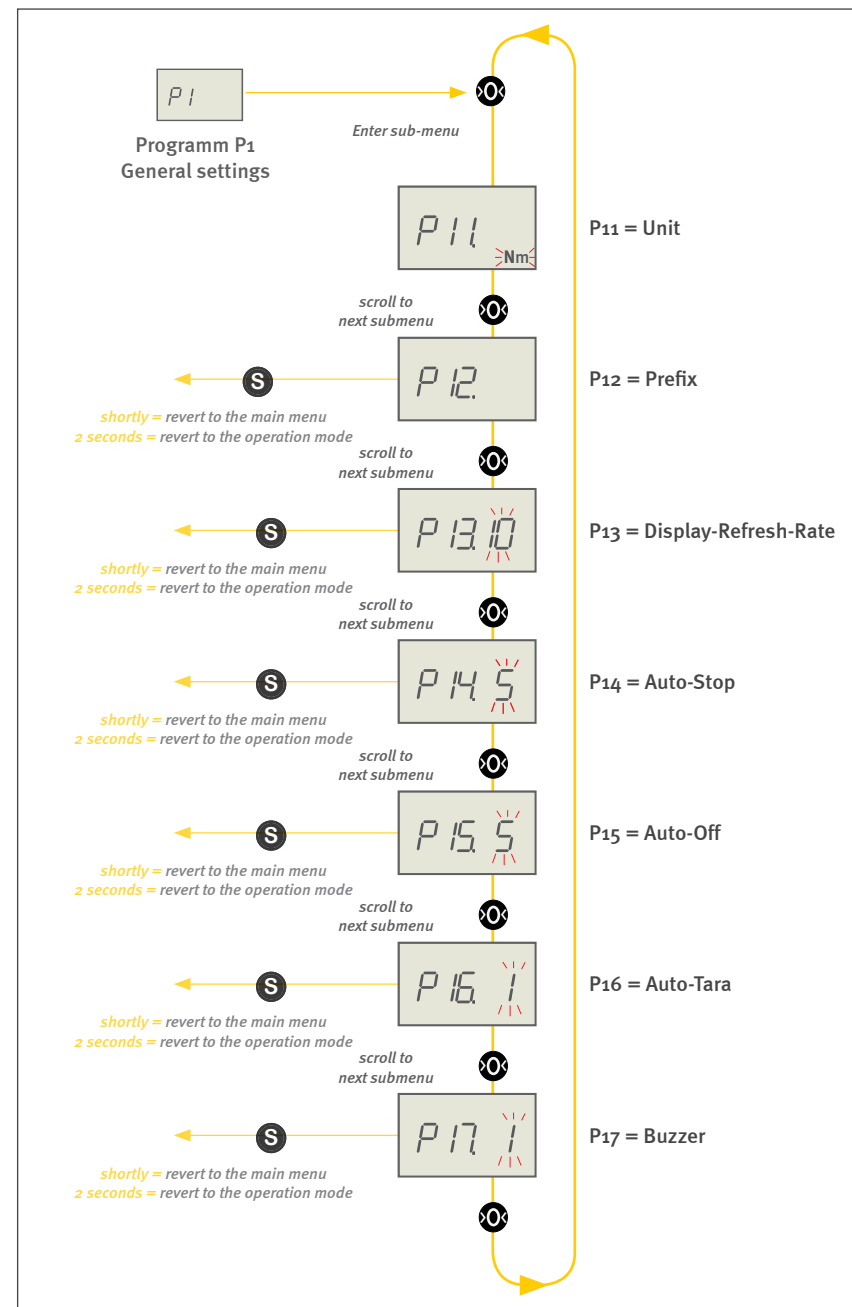

CTT-200 CTT-300

Bedienungsanleitung
Operation manual
Notice d'utilisation
Instrucciones de servicio
Istruzioni per l'uso

5.2.1. Change measuring unit (P11)

The SI unit newton metres (Nm) is the default setting. The measuring unit can be adjusted through submenu P11. Select the desired unit with the I-key. The active selection flashes on the display.

[Measuring-Unit: Nm - cNm]

Press for 2 seconds the S-key to revert back to the operation mode.

5.2.2. Change prefix for CCW mode and CW mode (P12)

Torques acting counterclockwise to the measuring object are by default shown as negative readings and clockwise measurement values accordingly as positive. The prefix may be changed in submenu P12. Select the desired prefix with the I-key.

[Clockwise () - Counterclockwise (-)]

Press for 2 seconds the S-key to revert back to the operation mode.

5.2.3. Display-refresh rate (P13)

The internal sensor captures torques with a maximum frequency of 3,6 kHz. To ensure the legibility of the display the display-refresh rate is limited by default to 10 Hz. Submenu P13 allows to reduce this value further. Press the I-key to select the desired frequency rate.

[Update-frequency: 1 - 2 - 3 - 5 - 10 Hz]

Press for 2 seconds the S-key to revert back to the operation mode.

5.2.4. Auto-Stop - automatic measuring stop (P14)

Measurements are stopped automatically when the measured values are stable for 5 seconds. Submenu P14 allows to adjust this period of time.

[Auto-Stop after: 5 - 10 - 20 - 30 Sekunden]

Press for 2 seconds the S-key to revert back to the operation mode.

Example changing parameters:
P13 - Display-refresh-rate

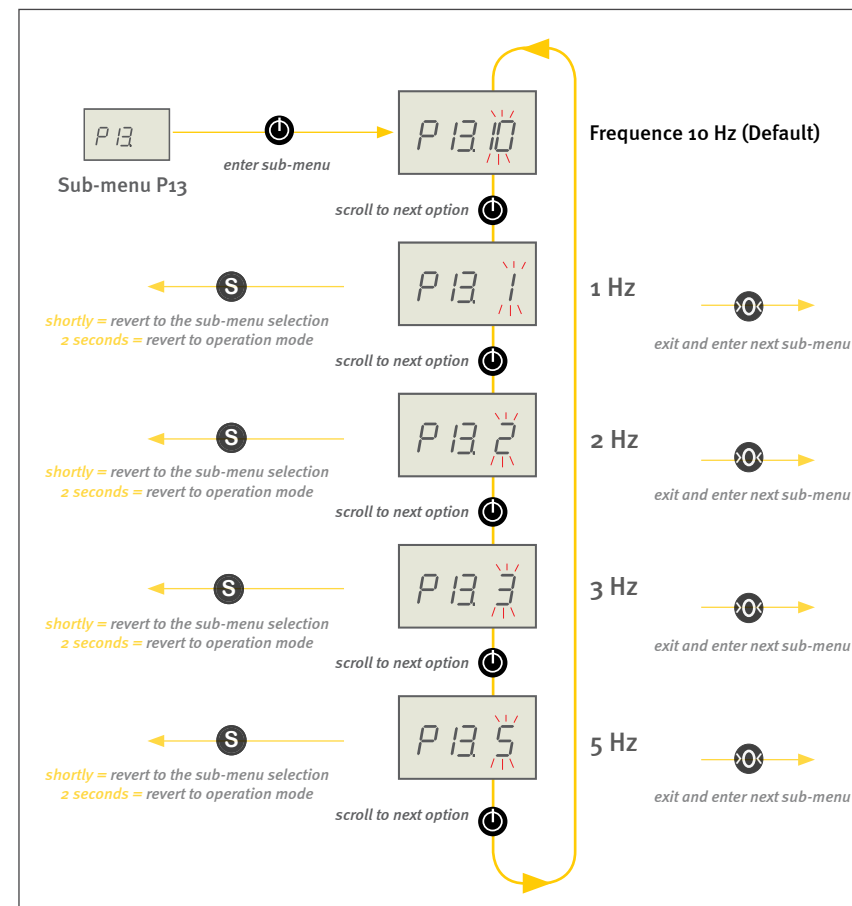

The selected option flashes

CTT-200

CTT-300

Bedienungsanleitung
Operation manual
Notice d'utilisation
Instrucciones de servicio
Istruzioni per l'uso

5.2.5. Auto-Off function (instrument off) (P15)

Cap torque testers CTT running without USB cable are turned off, if no key is pressed for more than five minutes. Submenu P15 allows to adjust this period of time by pressing the I-key.

[Auto Off after: 1 - 2 - 3 - 5 - 10 - 30 - 60 - 90 minutes]

Press for 2 seconds the S-key to revert back to the operation mode.

5.2.6. Auto-Tara - automatic taring (P16)

Instruments are taring automatically when starting a measurement (auto-tare function) to compensate for the weight of the test object and the occurring tension while applying force. In addition, there is an automatic compensation of the temperature drift.

Submenu P16 allows to deactivate this function. Select „0“ with the I-key to deactivate the auto-tara function.

[Auto-Tara: 1 = ON - 0 = OFF]

Press for 2 seconds the S-key to revert back to the operation mode.

5.2.7. Buzzer - activating the signal tone (P17)

The instruments can support limit value monitoring with acoustic signals. The audible signal (buzzer) is activated once the device is connected to an external power supply (universal power supply USB (FMI-946)). While measuring a steady tone sounds as long as the measured value is within the defined limit values. Once the limits are exceeded or not reached, the buzzer changes to an interrupted tone.

Menu P17 allows to turn off the beep. Select „0“ with the I-key to deactivate the buzzer.

[Buzzer: 1 = ON - 0 = OFF]

Press for 2 seconds the S-key to revert back to the operation mode.

CTT-200 CTT-300

Bedienungsanleitung
Operation manual
Notice d'utilisation
Instrucciones de servicio
Istruzioni per l'uso

5.3. Reset to factory defaults (PO)

Submenu PO allows to reset all settings to factory defaults. Select menu PO and press the O-key to enter the menu. The display shows PO1 and a flashing „0“ (= no reset). By pressing the I-key you can select „1“ (= reset). Confirm by pressing the S-key and all settings are reset to factory defaults. The display shows shortly „rESEt“.

If you decide not to reset the settings after having chosen „1“, select again „0“ by pressing the I-key and return to the operation level by pressing the S-key.

[Reset factory defaults: 0 = no Reset - 1 = Reset]

Factory settings

Type	Parameter	Default-Value
CTT-200 and CTT-300	Unit	Nm
	Prefix	Clockwise CW (no prefix shown)
	Display-refresh rate	10 Hz
	Auto-Stop	5 secs
	Auto-Off	5 min
	Auto-Tara	ON
	Acoustic signal (Buzzer)	ON
	Memory	OFF
	Measuring mode	Standard
	Limit values	all 0
CTT-300	Threshold for start of measuring 2. peak	50 % drop from 1. peak

Reset factory defaults

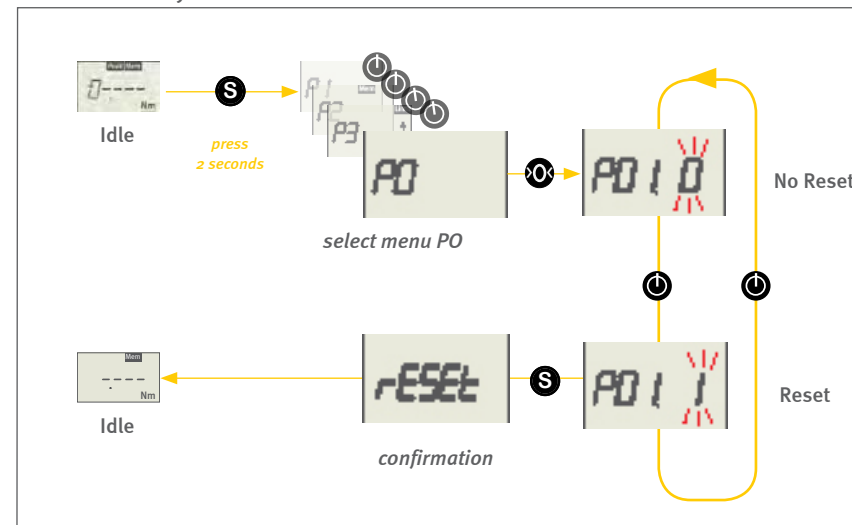

CTT-200

CTT-300

Bedienungsanleitung
 Operation manual
 Notice d'utilisation
 Instrucciones de servicio
 Istruzioni per l'uso

5.4. Memory and Statistics function (P2)

5.4.1. General explanation of the memory function

Cap Torque Tester CTT can store individual readings and show the results of simple statistical functions - maximum, minimum, average and deviation. Statistics are calculated for the data presently in memory.

Calculation of the standard deviation:

$$DEV = \frac{1}{n-1} \sum_{i=1}^n (x_i - \bar{x})^2$$

For comprehensive analysis we recommend data transfer via USB to your PC with the software FMI_Analyze (No. FMI 975). This allows the visualization of individual readings of a recording and further graphical analysis of measurement results.

5.4.2. Activating the memory and statistics function

The memory and statistics function is disabled at delivery of the instrument. Through parameter menu P2 you may activate or deactivate the function for storing individual values.

Press the 0-key to enter submenu P21 and select the desired storage function with the 1-key:

0 = no memory (Default)

1 = memory active

Once the storage and statistics function is activated, the **Mem** icon appears at the upper edge of the display.

Press for 2 seconds the S-key to revert back to the operation mode.

Activate the memory and statistics function

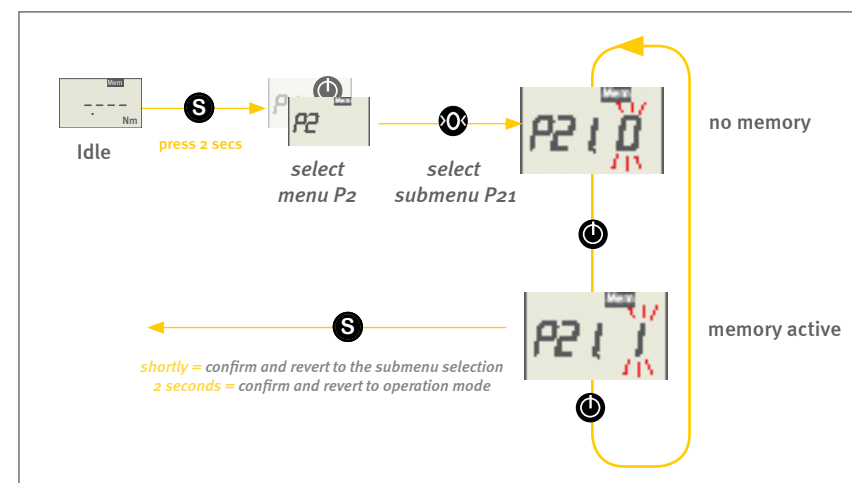

CTT-200

CTT-300

Bedienungsanleitung

Operation manual

Notice d'utilisation

Instrucciones de servicio

Istruzioni per l'uso

5.4.3. Storage of single values

Having activated the memory function (*Mem*) before, you can save a single value by pressing the S-key during an ongoing measurement. The measurement will stop and the stored value is displayed. This procedure can be repeated up to 1.000 times.

The stored measured values are appended to already existent stored values.

5.4.4. View statistics

To evaluate your measurements, we recommend the software FMI-Analyze. All stored values and the statistical values can be read by the software. If the instrument has not been turned off in between, this can be done even after the measurement. The Cap Torque Tester CTT must be connected with the PC during the measurement.

You may also view, after having finished the measurement, the statistical results on the display (see p. 18, chapter 4.8 „View readings“).

5.4.5. Clear memory

There are three ways to clear the memory:

- Delete the captured and stored readings individually by pressing the O-key. After deletion „0.00“ or „00.00“ appears on the display. Statistical values can not be deleted individually.
- Hold down the O-key until the idle symbol appears on the display, to clear all data (statistics and measurements) from the memory at the same time.
- By turning the equipment off the entire memory contents (statistics and measurements) will be deleted.

The idle symbol appears on the display when no more values and statistics are stored in the device.



Screen shows the idle symbol when memory is cleared

CTT-200 CTT-300

Bedienungsanleitung
Operation manual
Notice d'utilisation
Instrucciones de servicio
Istruzioni per l'uso

5.5. Monitoring limit values (P3 bis P6)

Limit value monitoring is a useful function in tolerance and process monitoring. With the Cap Torque Tester CTT the current measured value can be compared with previously set upper and lower limits. Exceeding values or values below these thresholds are signaled on the display. In addition, a buzzer sound is emitted and a signal output is switched accordingly. To use the outputs, a corresponding cable (Art. FMI 934SO) is needed. After the measurement a green/red LED signal indicates whether the measurement has passed or failed.

The limit function replaces the overload function of the instrument (provided the set limit value does not exceed the admissible overload).

5.5.1. Working with the limit value (threshold) function

If a limit value is set (at least one of the limit values is uneven zero) the limit function is activated and the display shows the **Limit** symbol. As long as the measured value is below the lower limit value a downward pointing arrow is shown on the right side of the display. Accordingly an upward pointing arrow is shown if the measured value surpasses the upper limit value. No arrow appears if the measured values are within the limits.

Once the limit value monitoring is enabled and an external power supply is connected, also the acoustic signal is activated. A continuous tone signals during the measurement, that the currently measured value is within the limits. If the values are above or below the upper or lower limit, the tone changes to a discontinuous sound. You can turn off the acoustic signal (see p. 25, chapter 5.2.7 „Buzzer - activating the signal tone“).

Visually, the limit value monitoring is supported by the LED indicator, if an external power supply is connected. After a measurement a green light indicates that the measured values were within the limits. The light is red if the measured values were above or below the limits.

In series CTT-300, in the operating modes **Peak CCW** and **Peak CW**, after a measurement „bad“ appears on the display, when one of the two peak values is out of limits.

Monitoring limit values with CTT-300

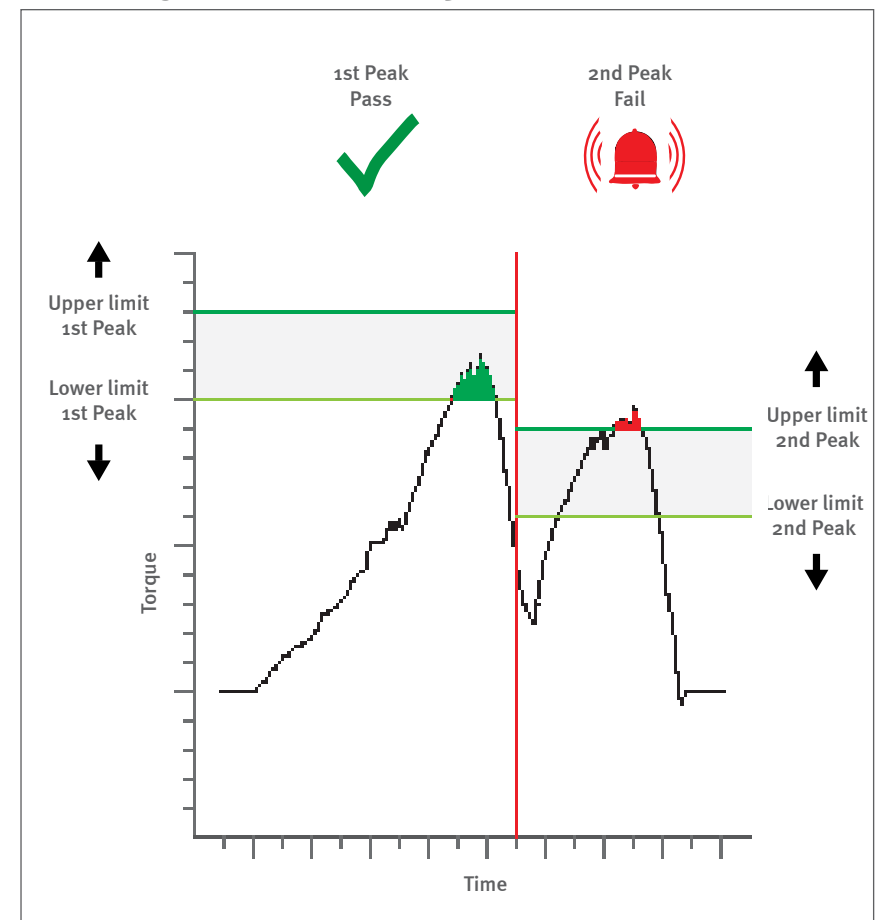

CTT-200 CTT-300

Bedienungsanleitung
Operation manual
Notice d'utilisation
Instrucciones de servicio
Istruzioni per l'uso

5.5.2. Setting limit values

Limits are set comfortable with the software FMI_Analyze on your PC.

You may also set limits through the parameter menus P3 for the upper limit and P4 for the lower limit.

Instruments CTT-300 series offer the possibility to set separate limits for the second peak: select the parameter menu P5 for the upper limit and menu P6 for the lower limit of the second peak.

Five digits appear on the display. A sixth digit is the prefix digit on the extreme left. By default no prefix is shown.

To enter limit values, the four digits from the right are available. The first digit is not enabled in the limit monitoring menus P3 to P6. Scroll with the O-key through the digits to select the digit you want to change. The currently active digit flashes. Then set the desired value with the I-key. Each press will increment by one.

By pressing the S-key you save the values and return to the parameter menu.

5.5.3. Delete limit values

You delete limit values by setting new values as described above. If all values are set to zero the limit value function is deactivated.

A reset of the instrument to factory defaults also resets the limit values. Whereas turning the instrument off or clearing all data from the memory does not delete limit values.

Display in in limit value menus

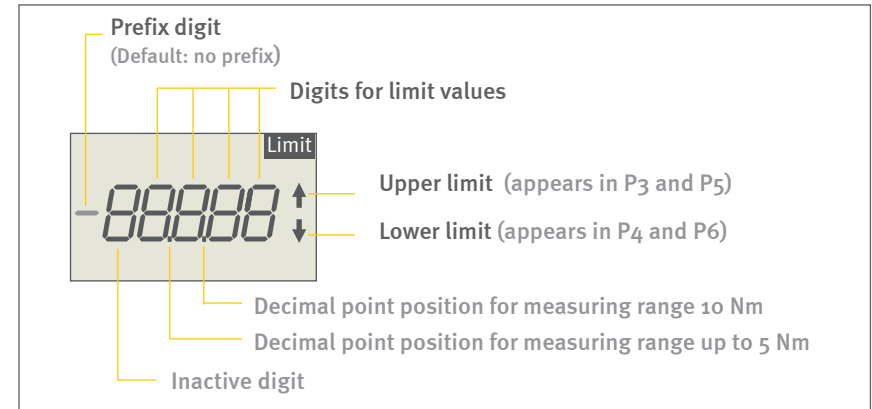

Example: Setting limit values (P3)

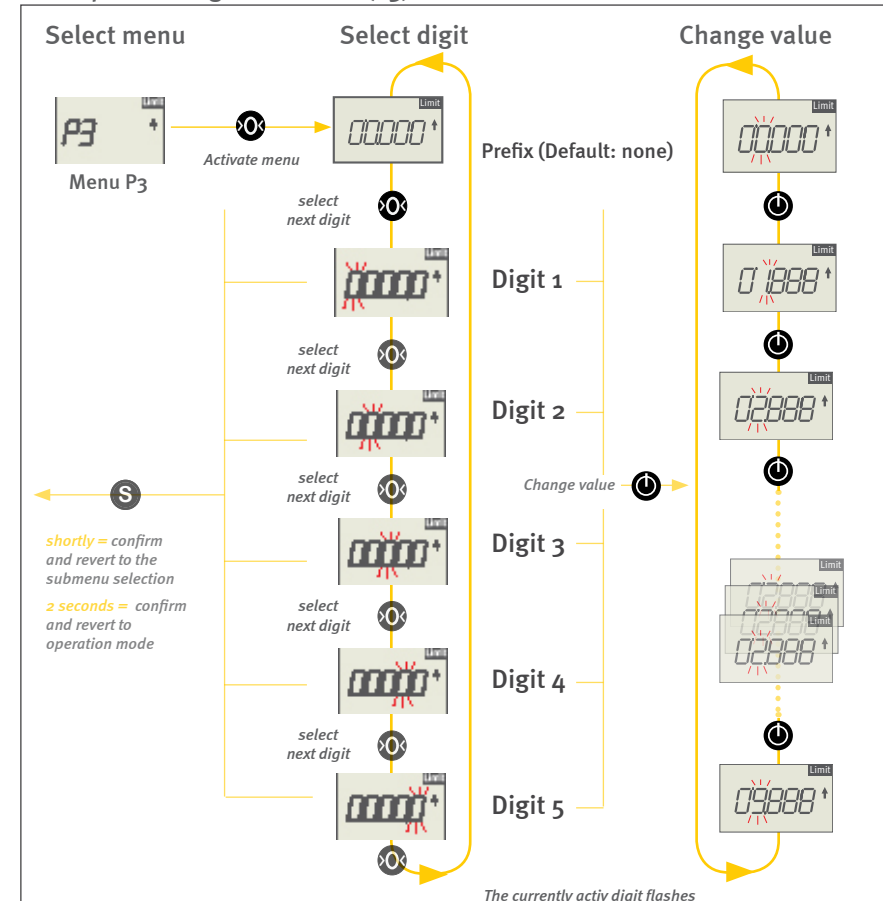

CTT-200

CTT-300

Bedienungsanleitung
 Operation manual
 Notice d'utilisation
 Instrucciones de servicio
 Istruzioni per l'uso

5.6. Threshold for start of 2nd peak measurement (P7)

Through menu P7 you can define at which point the instrument starts measuring the second peak. This threshold is defined as percentage of the first peak value.

By default the second peak measurement starts at a drop to 50 % of the first peak value (see chart). This value is indicated on the display at the beginning of the measurement of the second peak. Only if the reading exceeds this value again, the display changes.

To detect low or slightly pronounced second peak values you can adapt this threshold in 10 % steps to your application (see dashed curves).

Below 1 % of the instrument's maximum measuring range the passing on to the second peak will not be activated. That way an erratic start of the 2nd peak measurement by shaky curves at the start of the readings is inhibited.

[Start measuring 2. Peak at: 10 - 20 - 30 - 40 - 50 - 60 - 70 - 80 - 90 %]

Varying the threshold for starting the measurement of the 2nd peak:

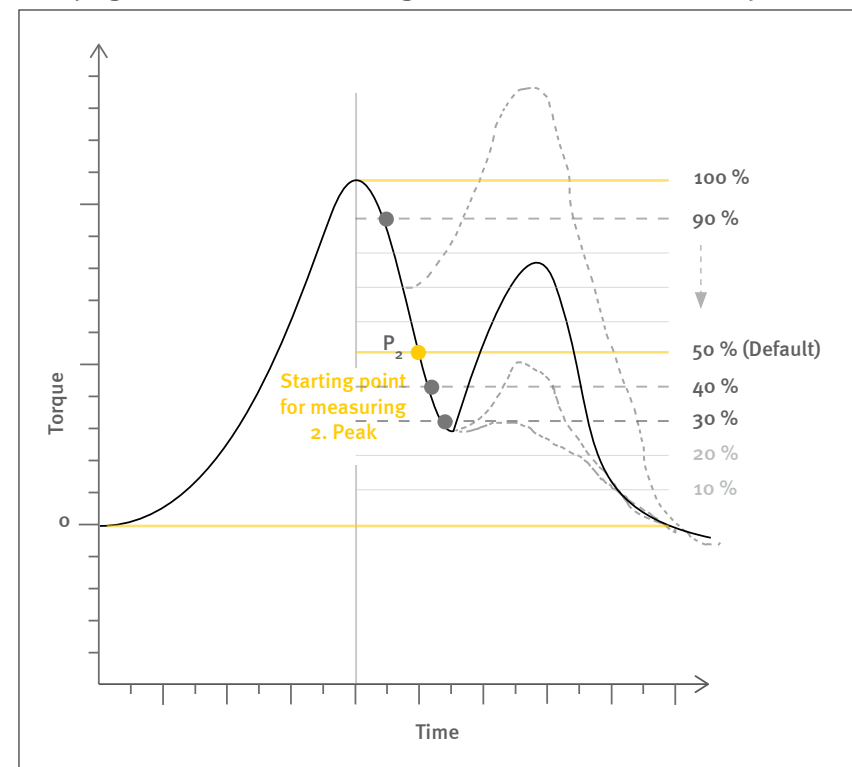

CTT-200

CTT-300

Bedienungsanleitung
Operation manual
Notice d'utilisation
Instrucciones de servicio
Istruzioni per l'uso

6.0 Data transfer

The Cap Torque Tester CTT can transfer measurement data and incidents such as „limit value exceeded“ or „overload“ via USB (2.0) or Hirose cable to a PC.

6.1. Data transfer via USB

For data transfer via USB an appropriate cable (part no.: FMI-931USB) and software with device driver is required.

6.1.1. Software FMI_Analyze

The software FMI_Analyze (part no: FMI-975) allows detailed visualization of your measuring results in diagrams, comparison with limit values or graphical specifications (e.g. windows with entrance and leaving definition) and the evaluation of measurement curves.

FMI_Analyze can be utilized also to configure the three additional digital outputs according to specific applications.

6.1.2. Software COM-Bridge

The software COM-Bridge allows direct data transfer from force gauges with USB interface to PC applications (e. g. Procella/Q-DAS®, specific applications etc.).

Data transfer can be configured to be carried out via the S-key on the instrument or an external foot switch. In the latter case connect a [foot switch](#) (Art. FMI-936) with Hirose connector to the Hirose-socket.

Software FMI_Analyze

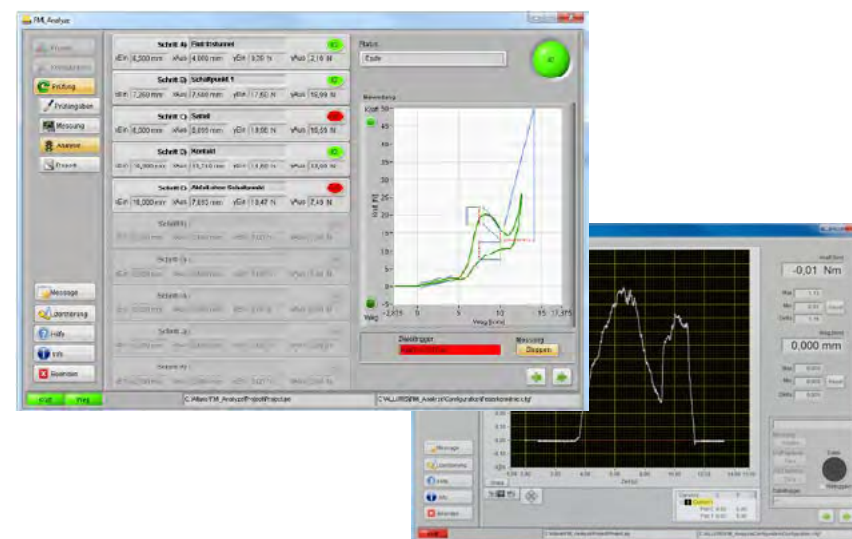

Reading interface

Software COM-Bridge

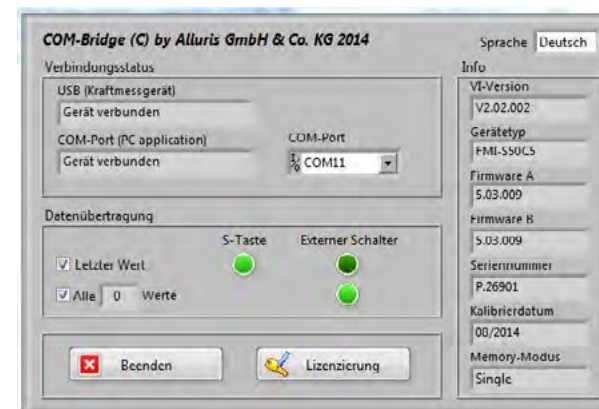

Screenshot Interface

CTT-200 CTT-300

Bedienungsanleitung
Operation manual
Notice d'utilisation
Instrucciones de servicio
Istruzioni per l'uso

6.2. Hirose socket

The Cap Torque Tester CTT have a 15-pin Hirose socket for several extension options and service functions.

6.2.1. Foot switch for data transfer

You may connect a foot switch with Hirose connector (part no.: FMI-936) to initiate data transfer. Combined with the software COM-Bridge data are easily transferred to PC applications such as CAQ software. The foot switch needs no additional power supply.

Length of cable: app. 3 m.

CTT-200

CTT-300

Bedienungsanleitung
 Operation manual
 Notice d'utilisation
 Instrucciones de servicio
 Istruzioni per l'uso

6.2.2. Data cable for digital I/Os

The cable with Hirose-socket (Art. FMI-934SO) allows:

- 3VDC power supply
- Digital input
- Trigger signal to synchronize measuring frequency
- Digital output/overload output

Cable assignment at wire end

	Colour	Assignment	Function
1	Weiss / White	Supply 3VDC	3VDC supply
2	Braun / Brown	GND	
3	Grün / Green	DIGIN ₁	Digital input
4	Gelb / Yellow	TRIGGER_OUT(C)	Trigger signal measuring frequency
5	Grau / Grey	TRIGGER_OUT(E)	
6	Orange / Orange	DIGOUT ₁ (C)	Digital output setting via FMI_Analyze
7	Blau / Blue	DIGOUT ₁ (E)	
8	Rot / Red	DIGOUT ₂ (C)	
9	Schwarz / Black	DIGOUT ₂ (E)	
10	Violett / Violet	DIGOUT ₃ (C)	
11	Schwarz-Weiss / Black-White	DIGOUT ₃ (E)	
12	Rot-Weiss / Red-White	LIMIT_MAX(C)	Digital limit-/overload output
13	Weiss-Grün / White-Green	LIMIT_MAX(E)	
14	Braun-Weiss / Brown-White	LIMIT_MIN(C)	
15	Weiss-Gelb / White-Gelb	LIMIT_MIN(E)	

Input:

Input voltage $U_{in} = 3...24\text{ V}$ (positive logic)

Internal resistance $R_i = 10\text{ k}\Omega$

Output:

Collector voltage $U_{CE} \leq 40\text{ V}$

Collector current $I_C \leq 40\text{ mA}$

Total power $P \leq 350\text{ mW}$

(E.g. max. operating points: 5 V@40 mA; 12 V@29 mA; 24 V@14 mA)

Connecting the digital outputs

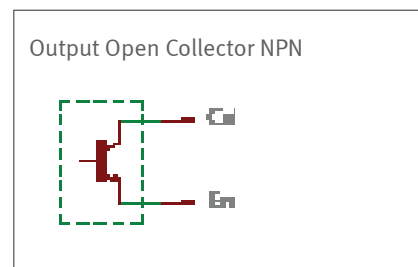

Connection example

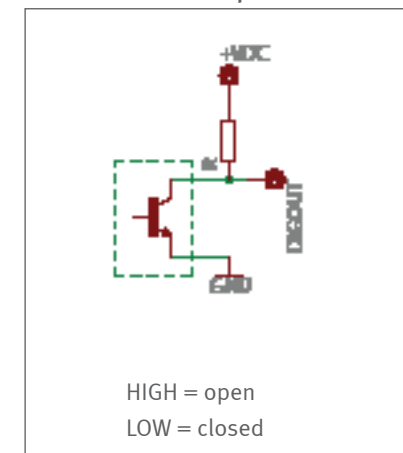

CTT-200 CTT-300

Bedienungsanleitung
Operation manual
Notice d'utilisation
Instrucciones de servicio
Istruzioni per l'uso

7.0 Dimensions and CAD files

You will find dimensional drawings and 3D-CAD files in the [Download-Area](#) on our website.

Product information regarding our [Cap Torque Tester CTT](#) are available on www.alluris.de.

For more comprehensive advise regarding specific applications we are happy to help you. Please do not hesitate to contact us.

Dimensional drawings are provided online

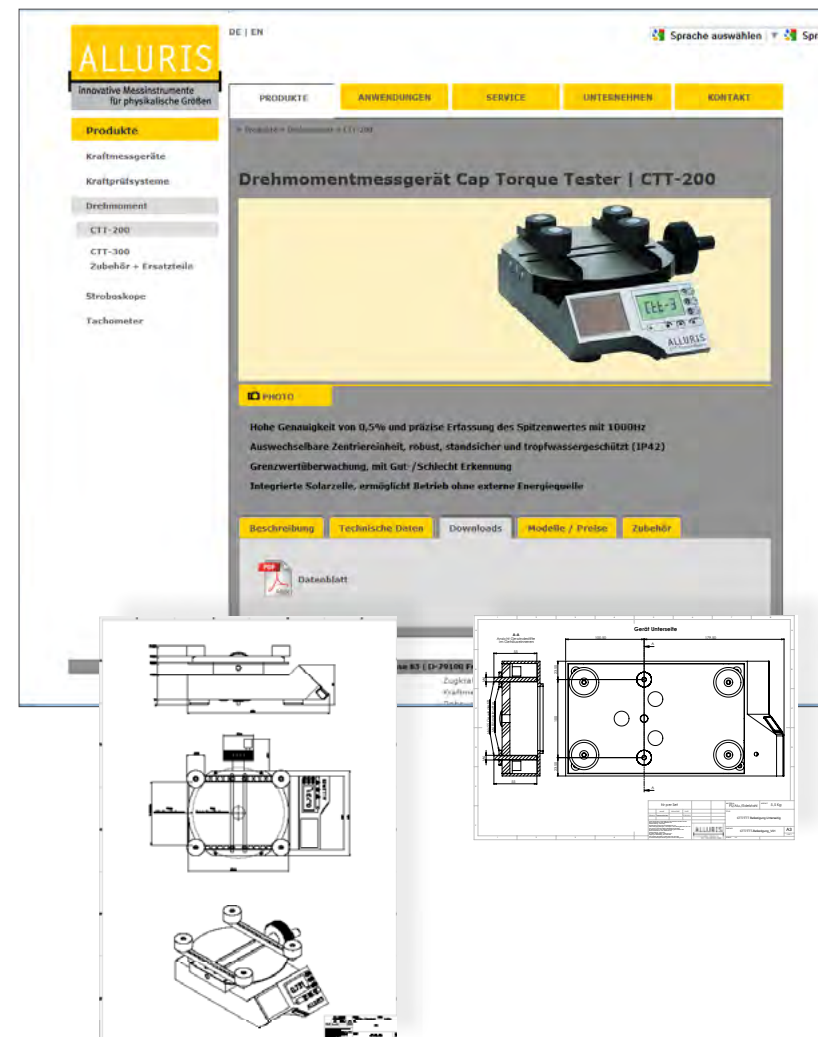

(Click for download)

CTT-200

CTT-300

8.0 Specifications

Bedienungsanleitung
 Operation manual
 Notice d'utilisation
 Instrucciones de servicio
 Istruzioni per l'uso

		CTT-200	CTT-300
Measuring range [Nm]	B2	2	
	B5	5	
	C1	10	
Resolution of display [Nm]	B2	0,002	
	B5	0,005	
	C1	0,01	
Measuring principle	bidirectional force sensor with strain gauge and high-speed μ -Processor		
Measuring frequency (internal)	up to 3,6 kHz		
Display refresh rate	1 - 10 Hz		
Peak capturing	app. 1 kHz		
Accuracy (f.s. ± 1 digit)	$\pm 0,5$ %		
Temperature offset (Tk relative) per K	$\pm 0,02$ %		
O-point offset (To absolute) per K	$\pm 0,02$ %		
Tracking (To suppressed)	Auto-Tara (automatic compensation)		
Overload output	●		
Overload	max. ± 20 Nm (Alarm at 140 % of measuring range)		
USB-interface, max. app. 1kHz	2.0		
Hirose	●		
2. Peak detection		●	
Memory function	●		
Statistics function	MAX / MIN		
	AVG / DEV		
Liimit function	●		
Operating temperature range	0° ... 40° (max. 85 %RH)		
Storage temperature	-10° ... 60° (dry conditions)		
Protection	IP 42 (against dripping water for up to 15° tilt device)		
Supply	Solar cell and internal HighCap-buffer		
Max. clamping	about 25 - 180 mm		
Weight	app. 5.000 g		
Dimensions (L x W x H)	280 x 170 x 95,3 mm		

The instruments are - with the exception of consumable and wearing parts - maintenance free.

Torque gauges should regularly be checked and calibrated. At least once a year, depending on the area of application and frequency of use, are checked and calibrated. Our calibration service includes a technical review of the device, calibration and, if necessary, the adjustment of the measuring range.

CTT-200

CTT-300

Bedienungsanleitung
Operation manual
Notice d'utilisation
Instrucciones de servicio
Istruzioni per l'uso

9.0 Service

9.1. Extended 5-year warranty

We extend the warranty to 5 years from the date of delivery, provided the equipment is registered with us immediately after purchasing and the maintenance and calibration intervals are observed. Excluded are wearing parts and consumables, as well as damage caused by improper use of the device. Otherwise, the warranty shall apply as agreed in our terms and conditions.

9.2. Product registration

To enjoy the extended warranty and to be automatically informed about the latest updates or product changes, we recommend to register your Cap Torque Tester CTT [online](#).

9.3. Calibration certificates

Cap Torque Tester CTT can be calibrated in our certified calibration laboratory working in accordance with DIN 17025.

Calibration can be performed according to the following standards and directives:

- VDI directive VDI/VDE 2646
- DAkkS (DKD) R 3-5

Traceability to the national standards of PTB/DKD is guaranteed and will be shown in the calibration certificates.

CTT-200

CTT-300

Bedienungsanleitung
 Operation manual
 Notice d'utilisation
 Instrucciones de servicio
 Istruzioni per l'uso

10.0 Frequently asked questions (FAQ)

<p>The depicted peak-value is higher than the maximum value!</p>	<p>The maximum value equals the average value of the last taken single values, whereas the amount of single values depends on the set display update time. The peak value, in contrast, is the absolute highest value measured.</p>
<p>Does the instrument work also after a being stored in the dark for a longer period?</p>	<p>Yes. Even after a self discharging of the internal energy storage the instrument can be used immediately. A back-up battery guarantees the basic function of the device (see p. 7, chapter 3.2 „Energy Harvesting“).</p>
<p>USB communication is disturbed!</p>	<p>Is the right device driver installed? Instruments CTT series must be turned on only after connecting via USB, else they can not be detected. Alternatively, press any button on the device.</p>
<p>The display shows “OvErL” !</p>	<p>Remove the excessive load immediately and check the instrument. If the indicated measuring values are obviously untrue the load cell has to be changed by the manufacturer.</p> <p>Important note: After overloading the device the calibration certificate becomes invalid.</p>
<p>The instrument turns off automatically!</p>	<p>The auto-off function turns off the instrument, if no button has been pressed for more than five minutes. This period of time can be changed and set between 1 und 90 minutes (see p. 25, chapter 5.2.5 „Auto-Off function“).</p>



CTT-200 CTT-300

Konformitätserklärung

**Declaration of
Conformity**

Déclaration de
Conformité

Declaración de
conformidad

Dichiarazione di
conformità

A. Appendix

A.1 Notes

The use of general descriptive names, trade names, trademarks, etc. in this manual, even if not specially labeled is not to imply that such names are exempt from the trademark and trade protection laws would have to be considered as free.

A.2 Calibration confirmation acc. DIN EN 10204 2.1

We hereby certify that the equipment has been tested in the production process in accordance with the requirements of DIN EN 9001: 2008. The force gauge fulfills all values and accuracy described in the technical data.

The instruments and sets of weights used to determine the accuracy are traceable to the globally accepted (ILAC) standards of the Physikalisch-Technische Bundesanstalt (PTB, Braunschweig) and DAkkS ([see p. 37, chapter 9.3 „Calibration certificates“](#)).

CTT-200 CTT-300

Konformitätserklärung

Declaration of Conformity

Déclaration de Conformité

Declaración de conformidad

Dichiarazione di conformità

A.3 Declaration of conformity

We hereby confirm that the below designated product is designed and manufactured in accordance to the general safety and health requirements of EC-Directive 2004/108/EG (EMC-electromagnetic compatibility), 2011/65/EG (RoHS) und der Richtlinie ST/SG/AC.10/11/Rev.5 Section 38.3/Amend.2 (Transport of Dangerous Goods). With any non-authorized changes of the device or application this declaration becomes void.

Manufacturer:	Alluris GmbH & Co. KG Basler Strasse 65 DE 79100 Freiburg, Germany	
Type Number:	CTT-200xx; CTT-300xx (see type label)	
Description:	Digital Torque Meter	
Serial number:	see type label	
Applicable standards:	EN 55022 (RF Emission)	Class B
	EN 61000-4-2 (ESD)	Criteria A
	EN 61000-4-3 (RF Field)	Criteria A
	EN 61000-4-4 (Burst)	Criteria A
	EN 61000-4-8 (Magn. Field)	Criteria A

The compliance to the requirements of all applicable EU directives is confirmed by the CE-marking of the product.

In accordance with WEEE Directive 2012/19/EU this device is categorized as “Monitoring and Control Instrument” and should not be disposed as unsorted municipal waste. You may return it to Alluris for recycling (WEEE Reg.No. DE 49318045). For more information please contact our website www.alluris.de.

Alluris GmbH & Co. KG
Freiburg (DE), 1 July 2015



(Klaus Hartkopf - CEO)

